

NEEDLE HOLDERS

Derf



20-0427-12 12 cm / 4 3/4"

Derf



20-0429-12 12.5 cm / 5"

Collier



20-0433-12 12.5 cm / 5"

**Halsey
Delicate**



20-0437-13 12.5 cm / 5"

20-0437-11 11 cm / 4 1/4"

Smooth jaws

**Webster
Delicate**

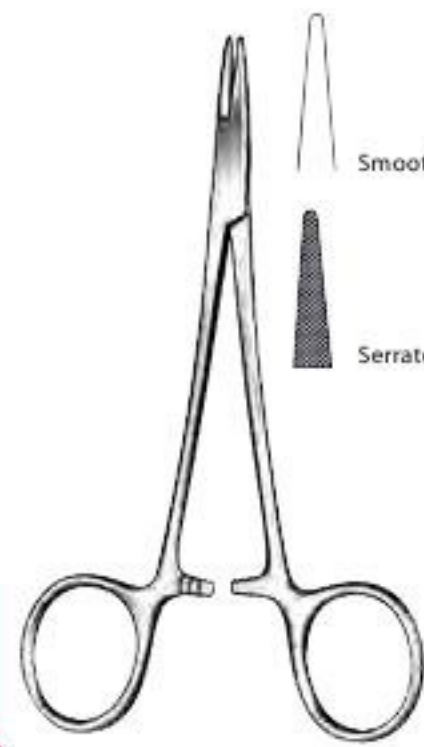

20-0435-13 13 cm / 5" Smooth

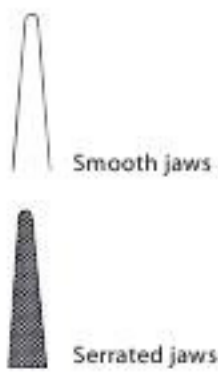

20-3001-13 Serrated

Neivert

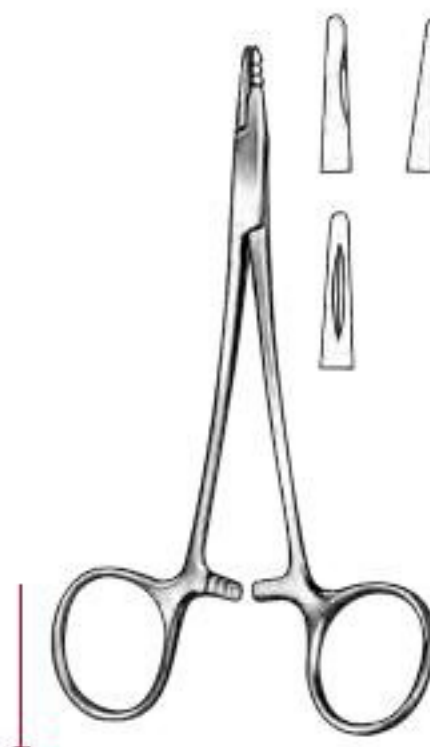

20-0439-13 13 cm / 5"

Kilner



20-0732-13 13.5 cm / 5 1/4"

Hegar-Baumgartner



20-0441-14 14 cm / 5 1/2"

Kelly



13-0431-14
Straight



13-0432-14
Curved

14 cm / 5½"

Kelly-Rankin



13-0435-16
13-3080-18
Straight



13-0436-16
13-3081-18
Curved

16 cm / 6¼"

18 cm / 7"

Crile



13-0441-14



13-0442-14

14 cm / 5½"



13-3085-14
1:2 Teeth



13-3086-14
1:2 Teeth

14 cm / 5½"

Crile-Rankin



13-0447-16
13-3095-18



13-0448-16
13-3096-18

16 cm / 6¼"

18 cm / 7"

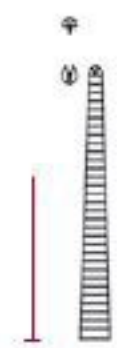

13-3090-16
13-3097-18
1:2 Teeth



13-3091-16
13-3098-18
1:2 Teeth

16 cm / 6¼"

18 cm / 7"

FORCEPS

Kelly Delicate



 13-3100-14 Straight	14 cm / 5½"	 13-3101-14 Curved
----------------------------	-------------	--------------------------

Kelly-Rankin Delicate



 13-3105-16 13-3105-18 Straight	16 cm / 6¼" 18 cm / 7"	 13-3106-16 13-3106-18 Curved
--	---------------------------	--

Crile Delicate





 13-3110-14	14 cm / 5½"	 13-3111-14
 13-3112-14 1:2 Teeth	14 cm / 5½"	 13-3113-14 1:2 Teeth

Crile-Rankin Delicate



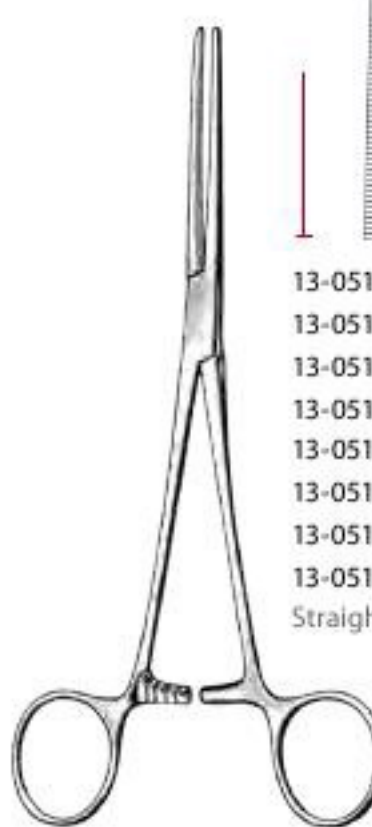

 13-3115-16 13-3120-18	16 cm / 6¼" 18 cm / 7"	 13-3116-16 13-3121-18
 13-3117-16 13-3122-18 1:2 Teeth	16 cm / 6¼" 18 cm / 7"	 13-3118-16 13-3123-18 1:2 Teeth



Rochester-Pean

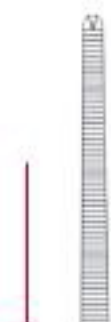

		
13-0511-14	14 cm / 5½"	13-0512-14
13-0511-16	16 cm / 6¼"	13-0512-16
13-0511-18	18 cm / 7"	13-0512-18
13-0511-20	20 cm / 8"	13-0512-20
13-0511-22	22 cm / 8¾"	13-0512-22
13-0511-24	24 cm / 9½"	13-0512-24
13-0511-26	26 cm / 10½"	13-0512-26
13-0511-30	30 cm / 12"	13-0512-30
Straight		Curved

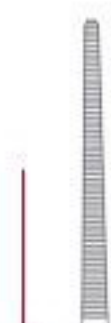

Rochester-Ochsner

		
13-0515-14	14 cm / 5½"	13-0516-14
13-0515-16	16 cm / 6¼"	13-0516-16
13-0515-18	18 cm / 7"	13-0516-18
13-0515-20	20 cm / 8"	13-0516-20
13-0515-22	22 cm / 8¾"	13-0516-22
13-0515-24	24 cm / 9½"	13-0516-24
13-0515-26	26 cm / 10½"	13-0516-26
13-0515-30	30 cm / 12"	13-0511-30
Straight		Curved

**Rochester-Pean
Delicate**

		
13-3186-14	14 cm / 5½"	13-3187-14
13-3186-16	16 cm / 6¼"	13-3187-16
13-3186-18	18 cm / 7"	13-3187-18
13-3186-20	20 cm / 8"	13-3187-20
13-3186-22	22 cm / 8¾"	13-3187-22
13-3186-24	24 cm / 9½"	13-3187-24
13-3186-26	26 cm / 10½"	13-3187-26
13-3186-30	30 cm / 12"	13-3187-30
Straight		Curved

**Rochester-Ochsner
Delicate**

		
13-3190-14	14 cm / 5½"	13-3191-14
13-3190-16	16 cm / 6¼"	13-3191-16
13-3190-18	18 cm / 7"	13-3191-18
13-3190-20	20 cm / 8"	13-3191-20
13-3190-22	22 cm / 8¾"	13-3191-22
13-3190-24	24 cm / 9½"	13-3191-24
13-3190-26	26 cm / 10½"	13-3191-26
13-3190-30	30 cm / 12"	13-3191-30
Straight		Curved

FORCEPS

Pean-Nippon

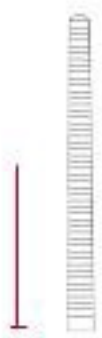

13-3193-14
13-3193-16
13-3193-18

14.5 cm / 5 3/4"
16.5 cm / 6 1/2"
18.5 cm / 7 1/4"



13-3194-14
13-3194-16
13-3194-18

Kocher-Nippon



13-3197-14
13-3197-16
13-3197-18
1:2 Teeth

14.5 cm / 5 3/4"
16.5 cm / 6 1/2"
18.5 cm / 7 1/4"



13-3198-14
13-3198-16
13-3198-18
1:2 Teeth

Dixon-Lovelace

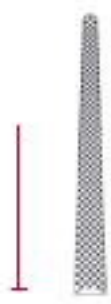

13-3200-16

16 cm / 6 1/4"

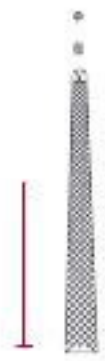

13-3201-16
1:2 Teeth

Heiss



13-3203-01

20 cm / 8"

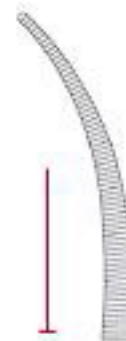

13-3203-02

20 cm / 8"



13-3203-03



13-3204-01
1:2 Teeth

20 cm / 8"

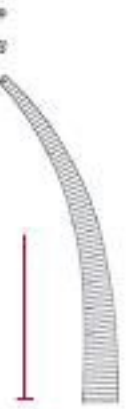

13-3204-02
1:2 Teeth

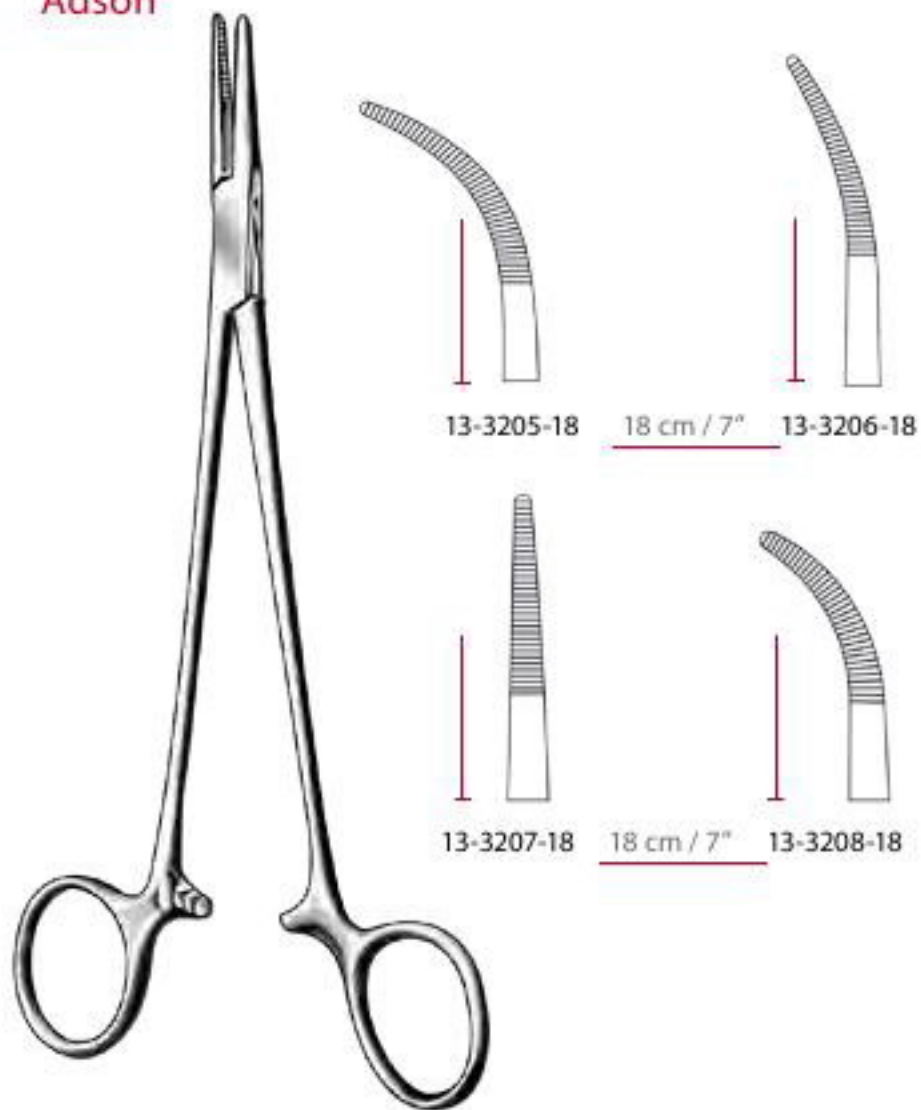
Adson

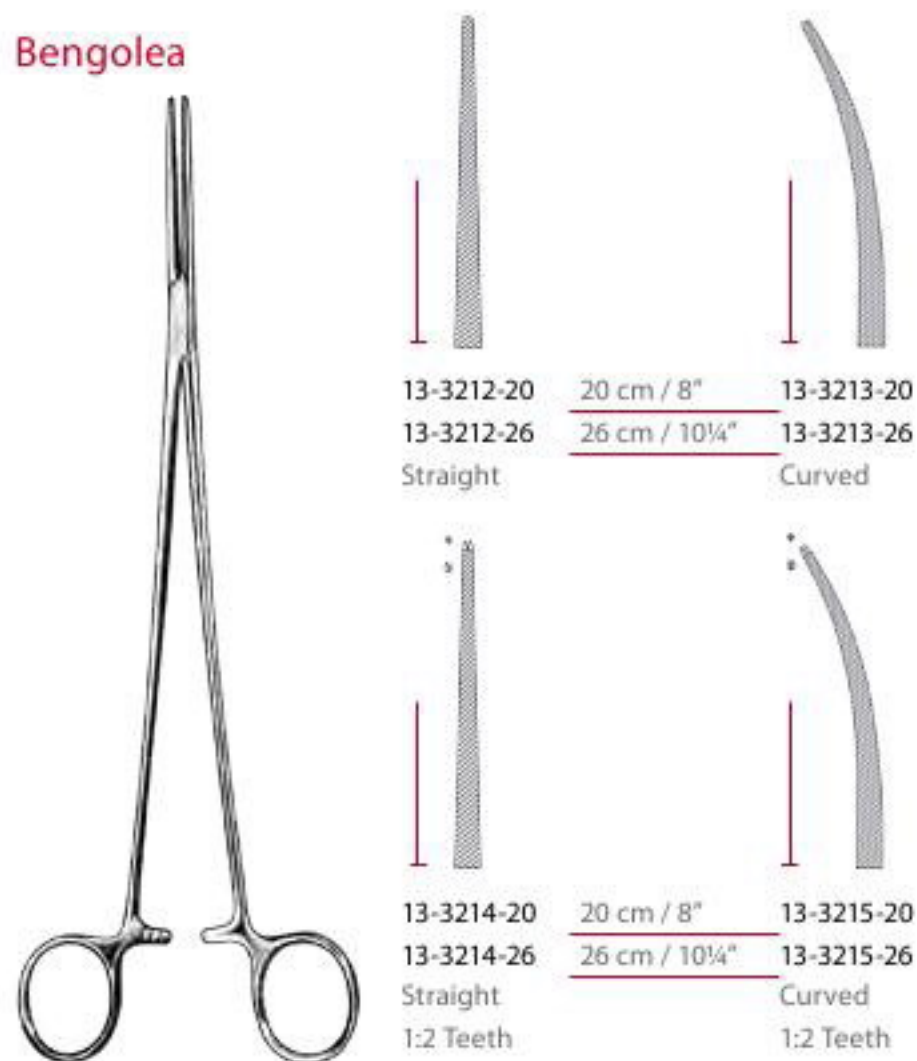
Rochester-Carmalt

Bengolea

Bainbridge

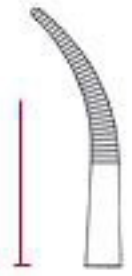
FORCEPS

Baby-Mixer



13-3390-14

14.5 cm / 5 1/2"



13-3391-14

Mixer



13-3395-14

14 cm / 5 1/2"

Mixer-Baby



13-0520-18

18 cm / 7"

Fergusson

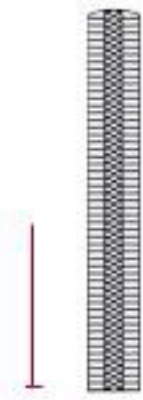

13-3295-17

17 cm / 6 3/4"

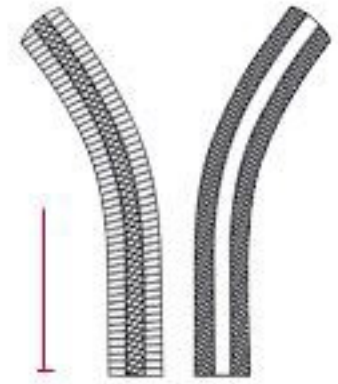

13-3296-17

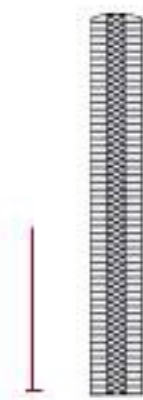

13-3295-20

20 cm / 8"

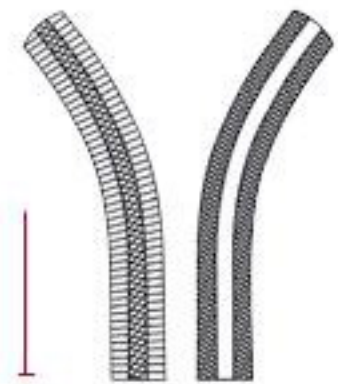

13-3296-20

Jones

13-0982-05 5 cm / 2"
 13-0982-09 9 cm / 3½"

Schaedel

13-0976-09 9 cm / 3½"

English Model

13-3625-09 9 cm / 3½"

Backhaus

13-1016-09 9 cm / 3½"
 13-1016-11 11 cm / 4¼"
 13-1016-13 13 cm / 5"
 13-1016-15 15 cm / 6"

Roeder

13-3630-11 11 cm / 4¼"
 13-3630-13 13 cm / 5"
 13-3630-15 15 cm / 6"

Lorna

13-1020-10 10 cm / 4"
 13-1020-13 13 cm / 5"

Foerster

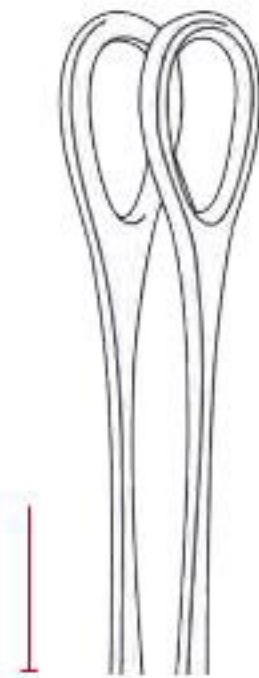

14-3055-25 25 cm / 10"
Smooth jaws

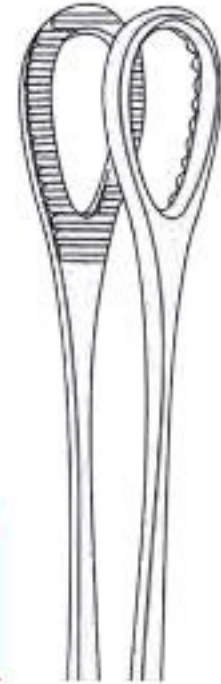

14-3056-18 18 cm / 7"
14-3056-20 20 cm / 8"
14-3056-25 25 cm / 10"

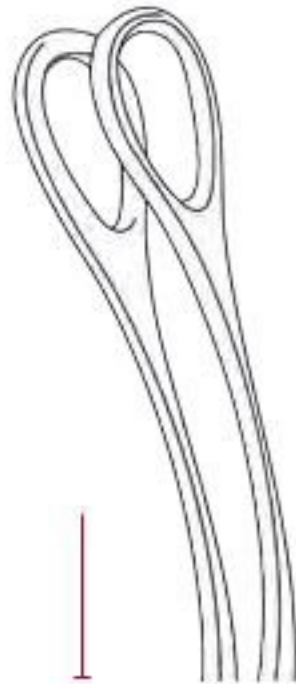

14-3057-25 25 cm / 10"
Smooth jaws

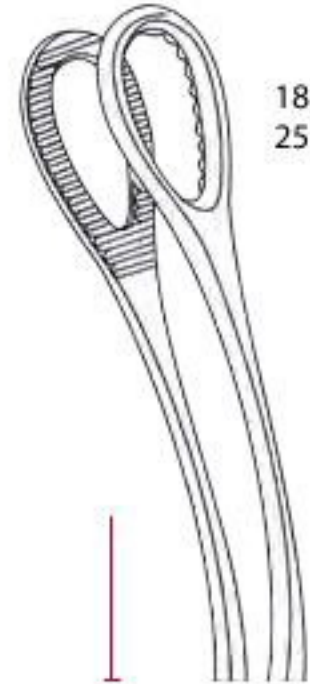

18 cm / 7"
25 cm / 10"
14-3058-18 -
14-3058-20 20 cm / 8"
14-3058-24 -

Adson

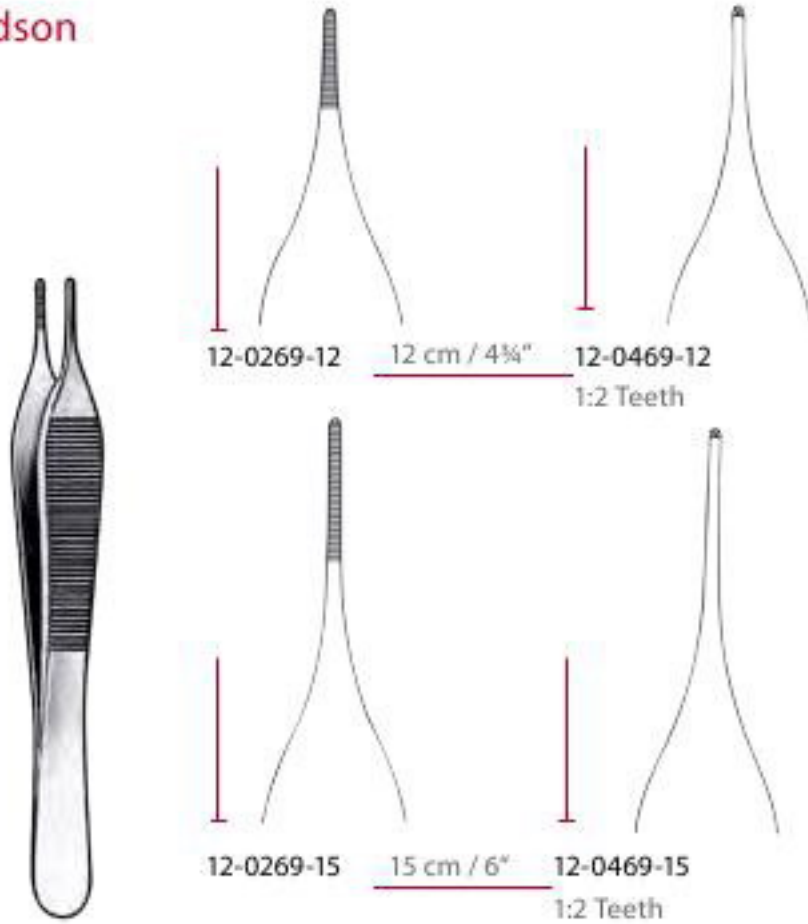

McIndoe



Standard

Standard Narrow

Tissue

Tissue

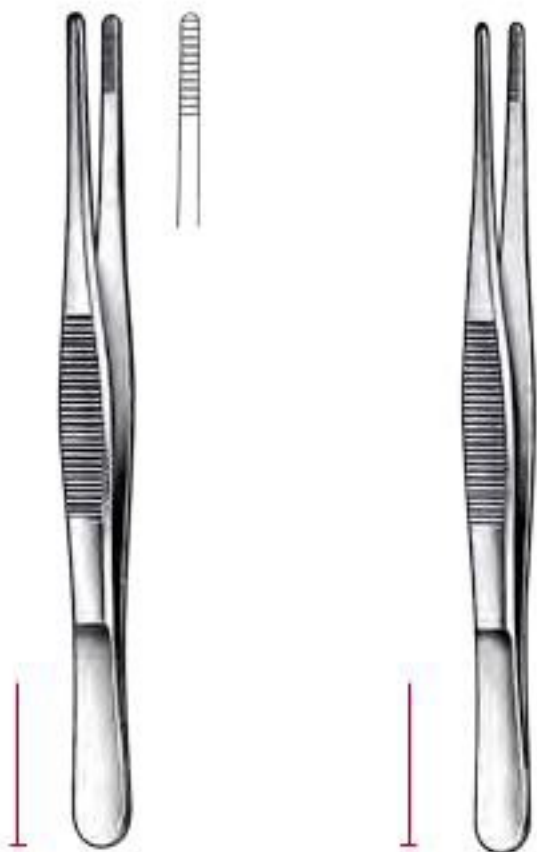

12-0201-10	10 cm / 4"	12-0221-10
12-0201-11	11.5 cm / 4 1/2"	12-0221-11
12-0201-13	13 cm / 5"	12-0221-13
12-0201-14	14.5 cm / 5 1/2"	12-0221-14
12-0201-16	16 cm / 6 1/4"	12-0221-16
12-0201-18	18 cm / 7"	12-0221-18
12-0201-20	20 cm / 8"	12-0221-20
12-0201-23	23 cm / 9"	12-0221-23
12-0201-25	25 cm / 10"	12-0221-25
12-0201-30	30 cm / 12"	12-0221-30

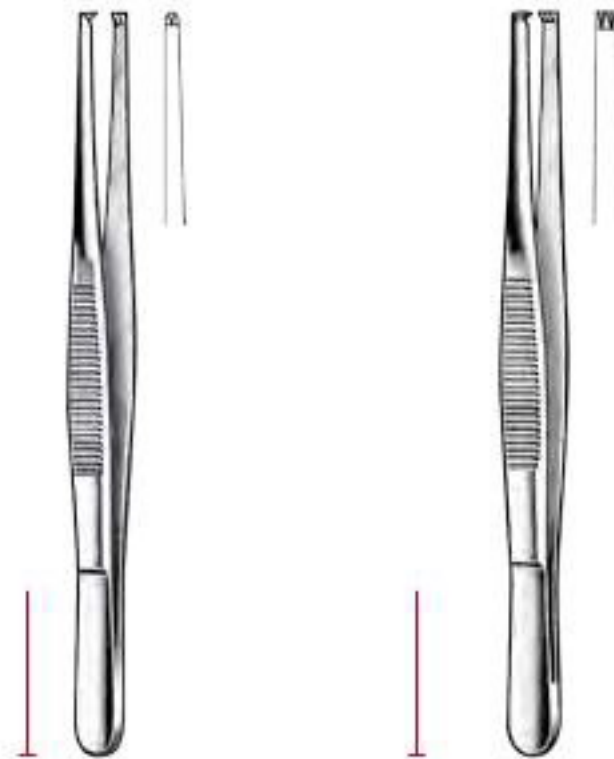

12-0402-10	10 cm / 4"	12-3020-10
12-0402-11	11.5 cm / 4 1/2"	12-3020-11
12-0402-13	13 cm / 5"	12-3020-13
12-0402-14	14.5 cm / 5 1/2"	12-3020-14
12-0402-16	16 cm / 6 1/4"	12-3020-16
12-0402-18	18 cm / 7"	12-3020-18
12-0402-20	20 cm / 8"	12-3020-20
12-0402-23	23 cm / 9"	12-3020-23
12-0402-25	25 cm / 10"	12-3020-25
12-0402-30	30 cm / 12"	12-3020-30
1:2 Teeth		2:3 Teeth

DRESSING & TISSUE DRESSING

Tissue



12-3025-13	13 cm / 5"	12-3030-13
12-3025-14	14.5 cm / 5½"	12-3030-14
12-3025-16	16 cm / 6¼"	12-3030-16
3:4 Teeth		4:5 Teeth

USA Standard Model



12-3035-10	10 cm / 4"
12-3035-13	13 cm / 5"
12-3035-14	14.5 cm / 5½"
12-3035-15	15.5 cm / 6"
12-3035-18	18 cm / 7"
12-3035-21	21 cm / 8¼"
12-3035-25	25 cm / 10"
12-3035-31	31 cm / 12¼"

USA Standard Narrow



12-3040-12	12 cm / 4¾"
12-3040-13	13 cm / 5"
12-3040-14	14.5 cm / 5½"
12-3040-15	15 cm / 6"

USA Model



12-3045-12	12 cm / 4¾"
12-3045-13	13 cm / 5"
12-3045-14	14.5 cm / 5½"
12-3045-15	15.5 cm / 6"
12-3045-18	18 cm / 7"
12-3045-21	21 cm / 8¼"
12-3045-25	25 cm / 10"
12-3045-31	31 cm / 12¼"
1:2 Teeth	

Stille



12-3050-15 15 cm / 6"



12-3055-15 1:2 Teeth



12-3060-15 2:3 Teeth

Micro-Adson

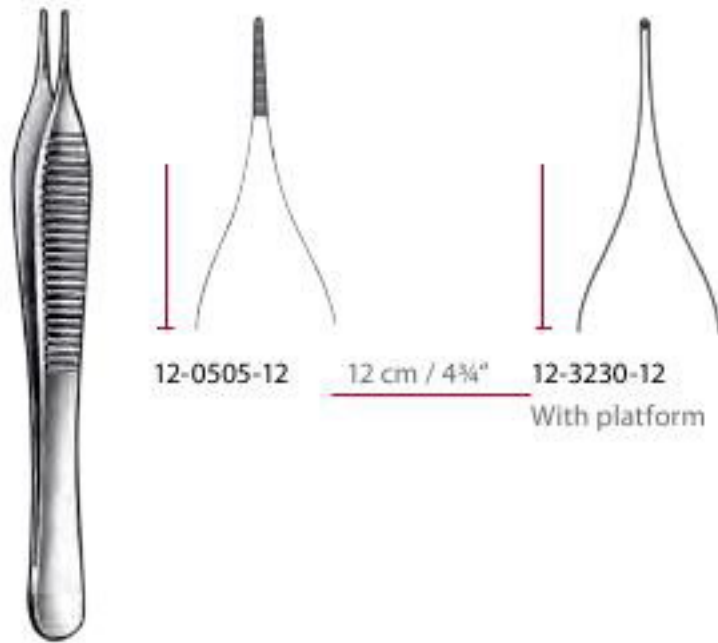

Adson-Brown

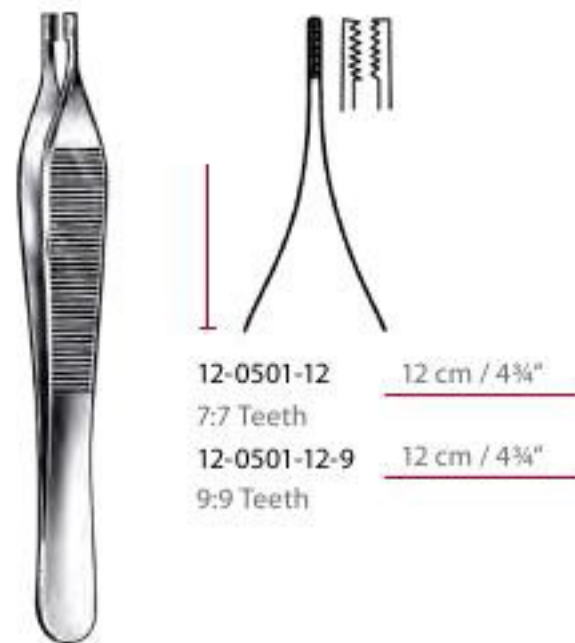

Iris

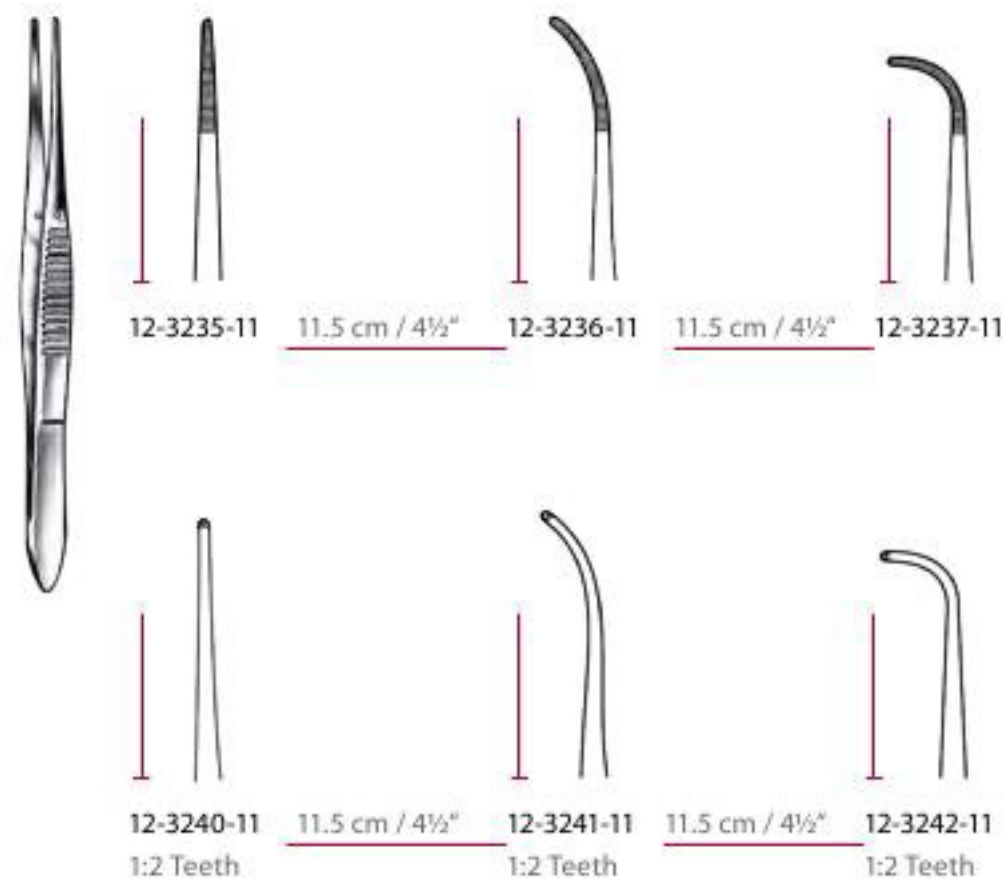

Feilchenfeld



DRESSING & TISSUE FORCEPS. with Tungsten Carbide Inserts

Oehler, TC

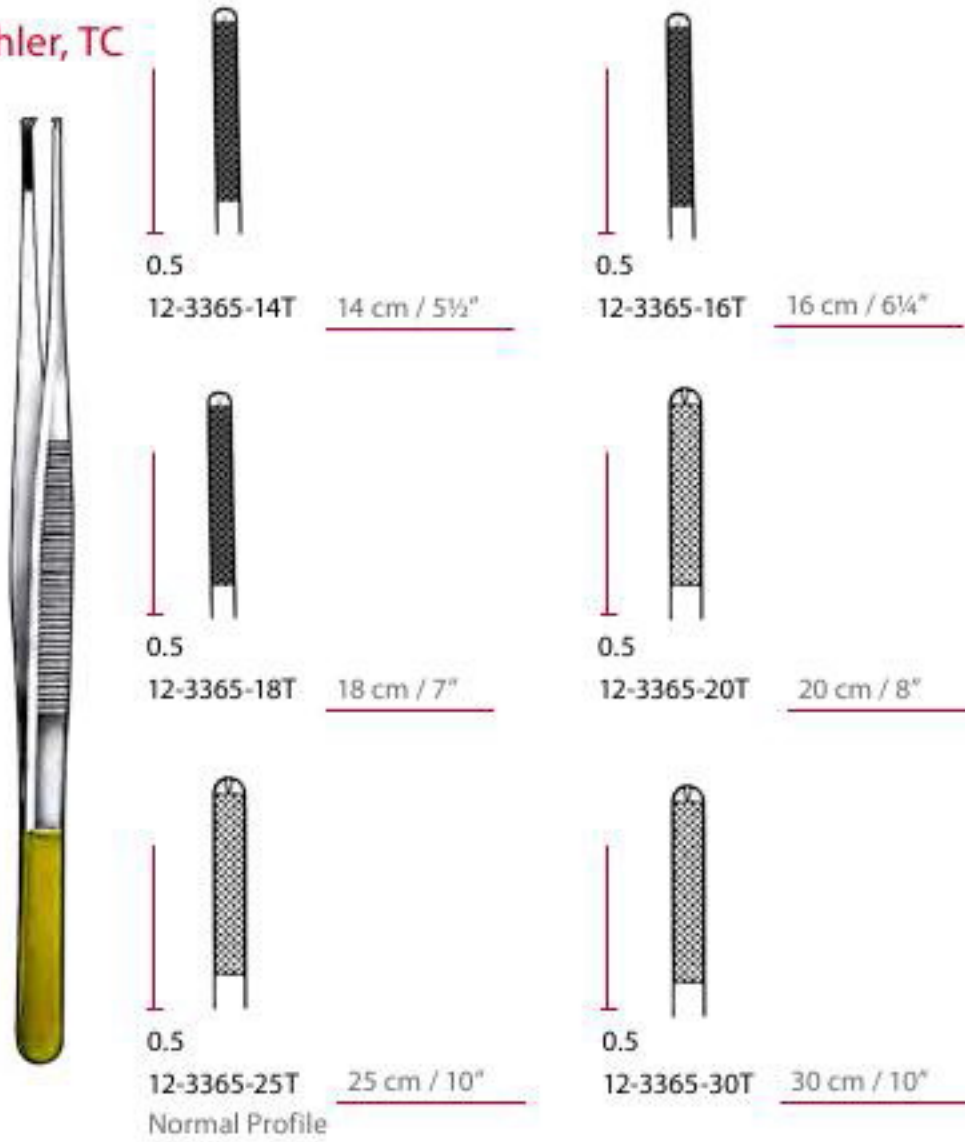

Standard, TC



Adson, TC

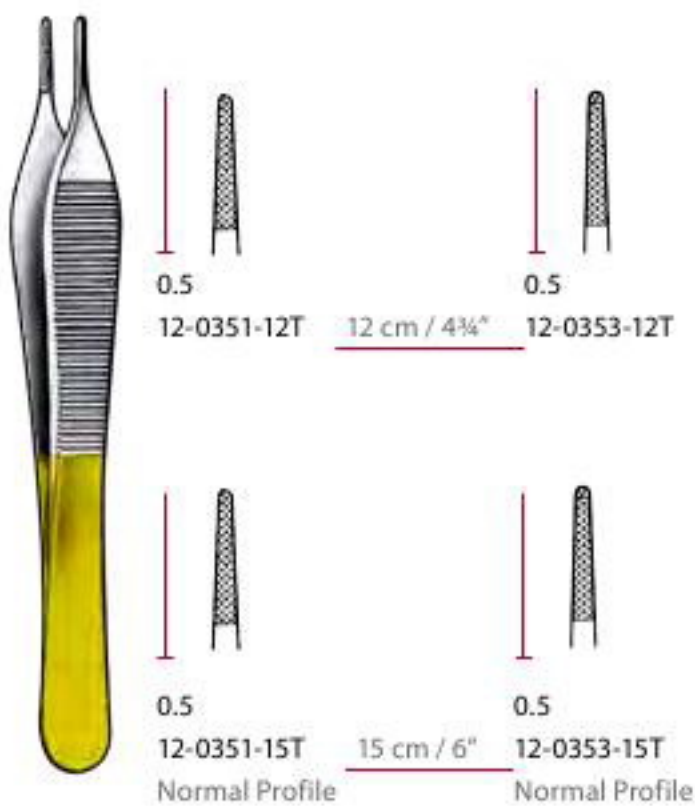

Micro Adson, TC

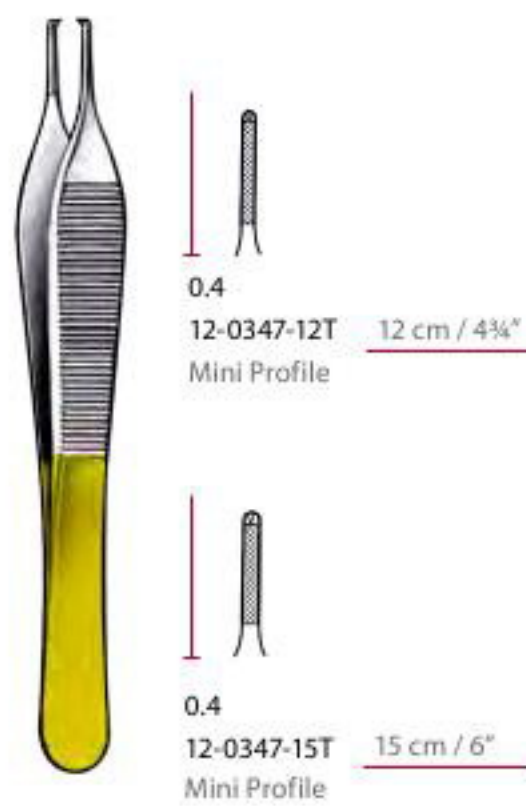

Adson Brown, TC

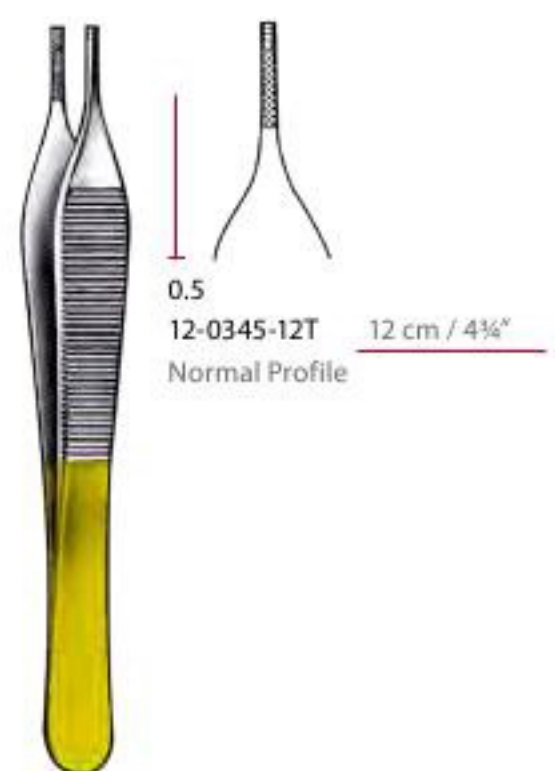

Standard

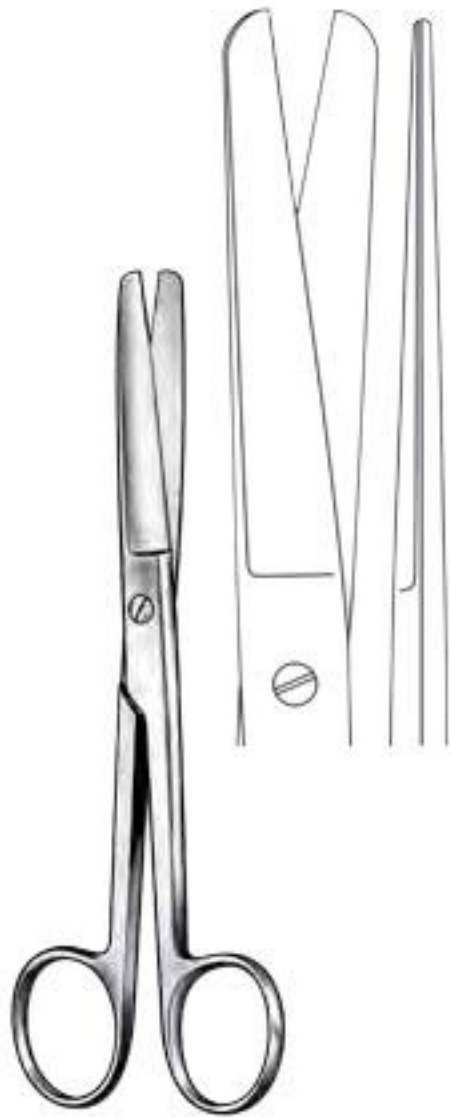

11-0201-10	10.5 cm / 4¼"
11-0201-11	11.5 cm / 4½"
11-0201-13	13.0 cm / 5"
11-0201-14	14.5 cm / 5½"
11-0201-15	15.5 cm / 6"
11-0201-16	16.5 cm / 6½"
11-0201-18	18.5 cm / 7¼"
11-0201-20	20.0 cm / 8"
Straight	

Standard

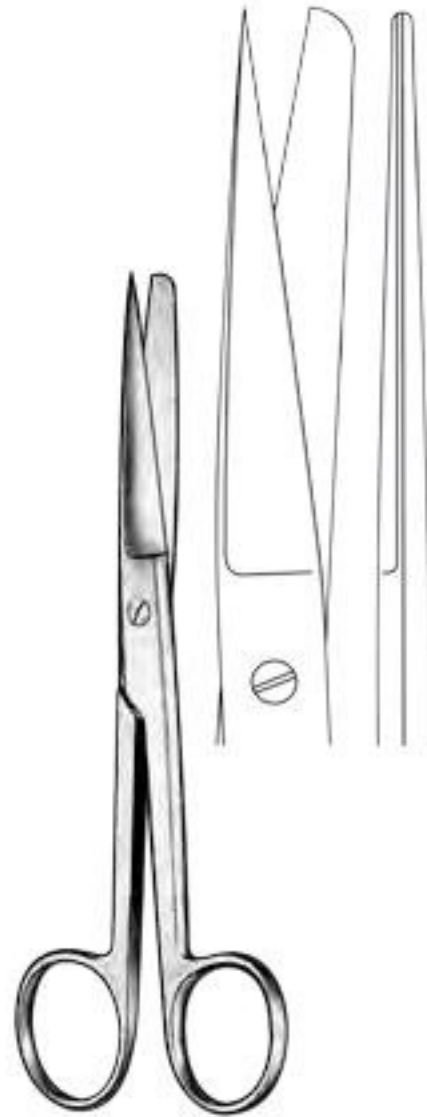

11-0203-10	10.5 cm / 4¼"
11-0203-11	11.5 cm / 4½"
11-0203-13	13.0 cm / 5"
11-0203-14	14.5 cm / 5½"
11-0203-15	15.5 cm / 6"
11-0203-16	16.5 cm / 6½"
11-0203-18	18.5 cm / 7¼"
11-0203-20	20.0 cm / 8"
Straight	

Standard

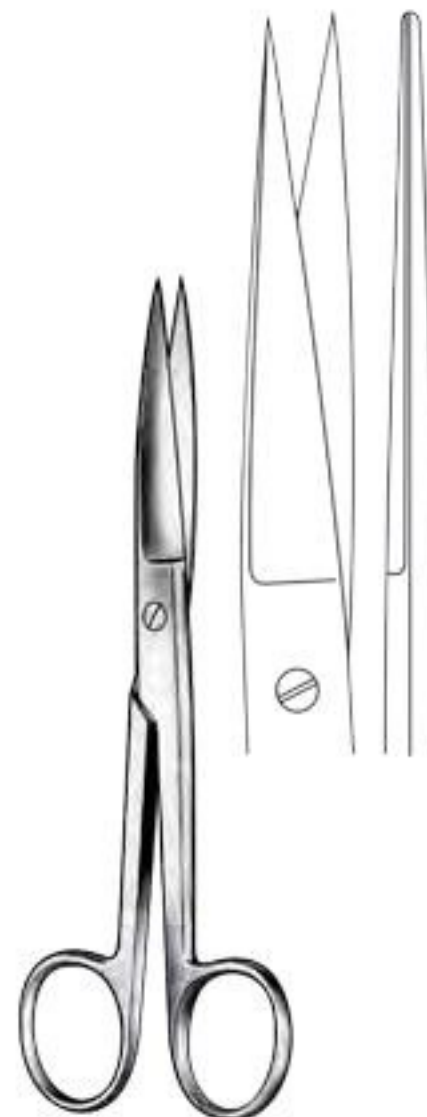

11-0205-10	10.5 cm / 4¼"
11-0205-11	11.5 cm / 4½"
11-0205-13	13.0 cm / 5"
11-0205-14	14.5 cm / 5½"
11-0205-15	15.5 cm / 6"
11-0205-16	16.5 cm / 6½"
11-0205-18	18.5 cm / 7¼"
11-0205-20	20.0 cm / 8"
Straight	

SCISSORS

Standard

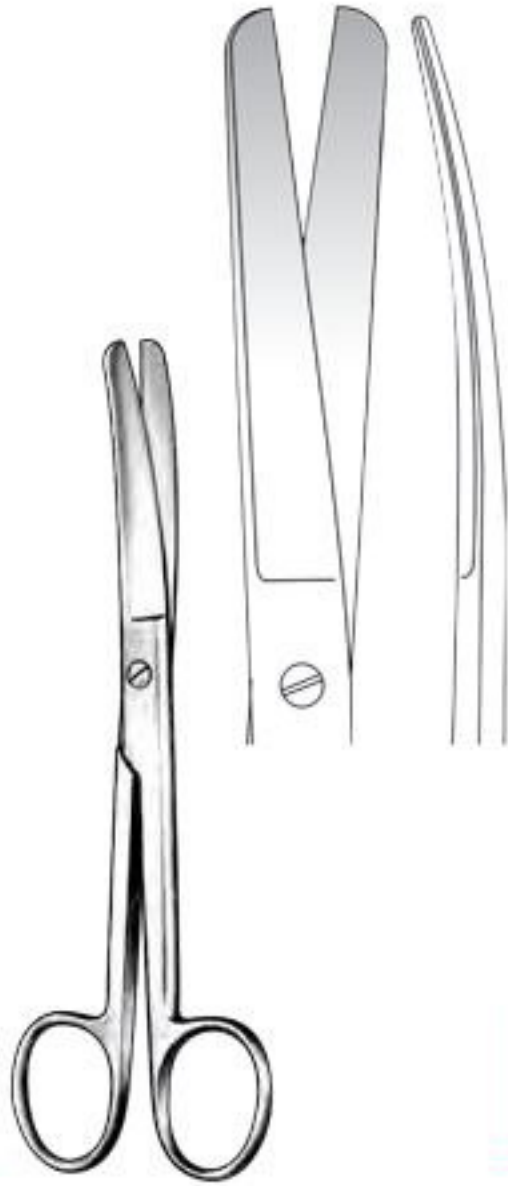

11-0206-11	11.5 cm / 4½"
11-0206-13	13.0 cm / 5"
11-0206-14	14.5 cm / 5½"
11-0206-15	15.5 cm / 6"
11-0206-16	16.5 cm / 6½"
11-0206-18	18.5 cm / 7¼"
11-0206-20	20.0 cm / 8"

Curved

Standard

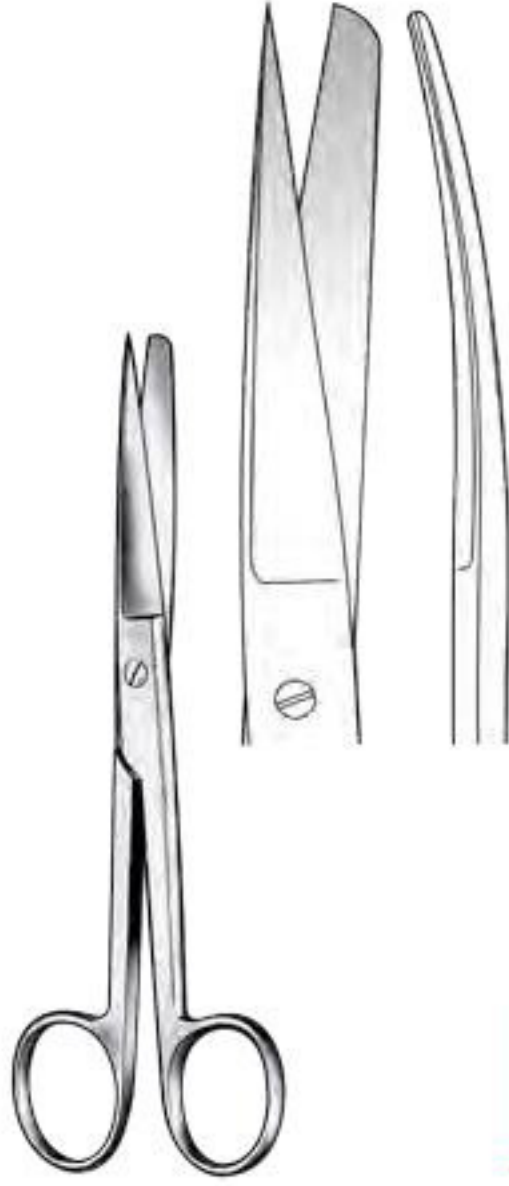

11-0208-11	11.5 cm / 4½"
11-0208-13	13.0 cm / 5"
11-0208-14	14.5 cm / 5½"
11-0208-15	15.5 cm / 6"
11-0208-16	16.5 cm / 6½"
11-0208-18	18.5 cm / 7¼"
11-0208-20	20.0 cm / 8"

Curved

Standard

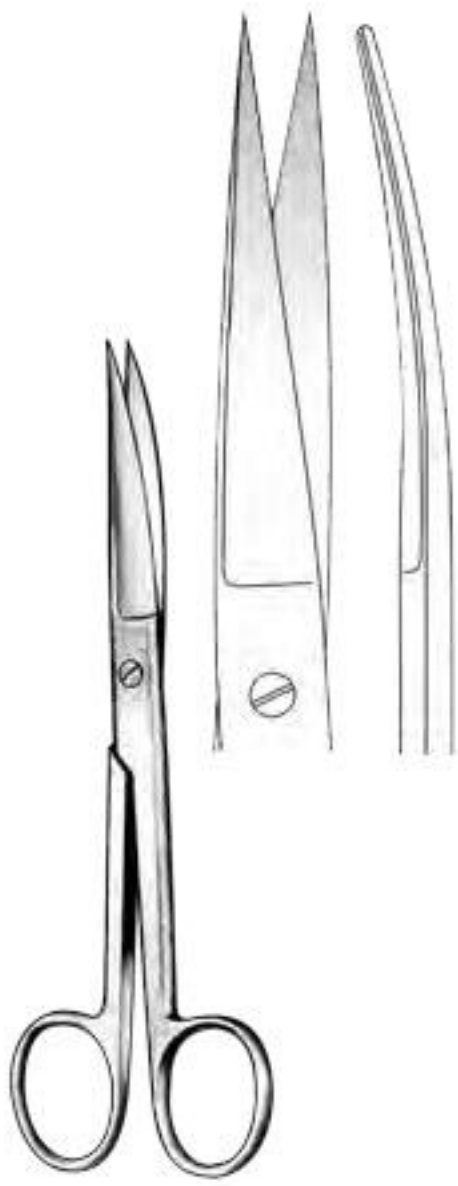

11-0210-11	11.5 cm / 4½"
11-0210-13	13.0 cm / 5"
11-0210-14	14.5 cm / 5½"
11-0210-15	15.5 cm / 6"
11-0210-16	16.5 cm / 6½"
11-0210-18	18.5 cm / 7¼"
11-0210-20	20.0 cm / 8"

Curved

Mayo



Mayo Harrington

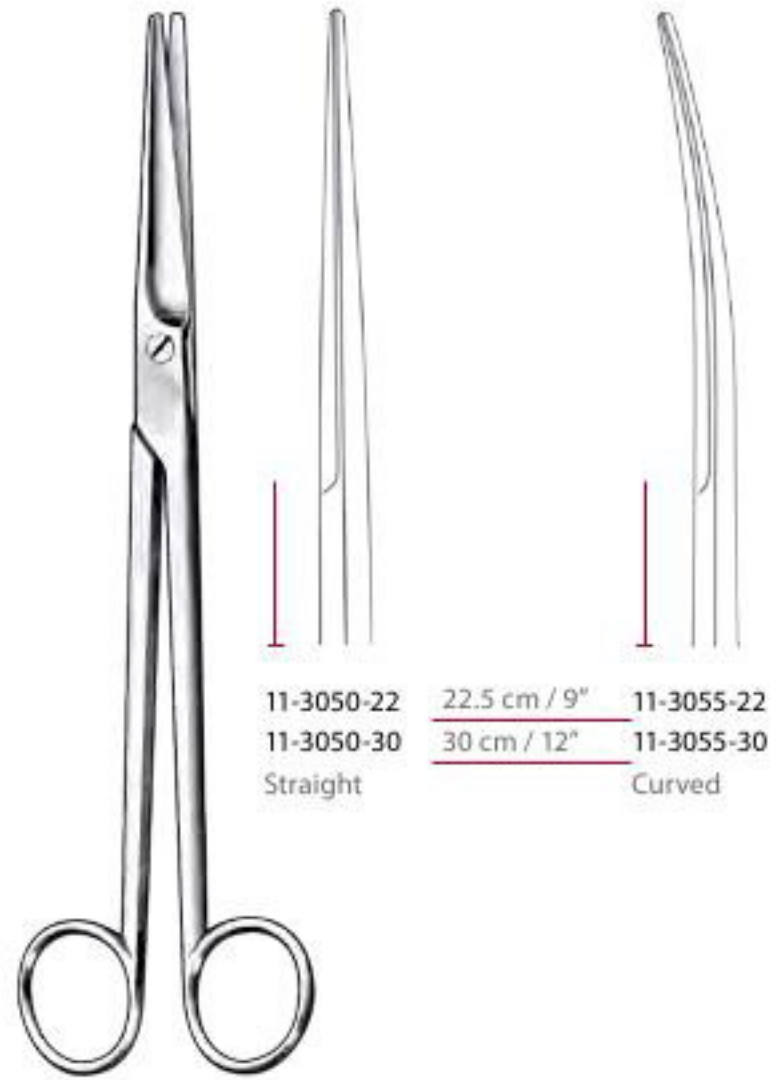

Mayo Stille



Mayo-Noble

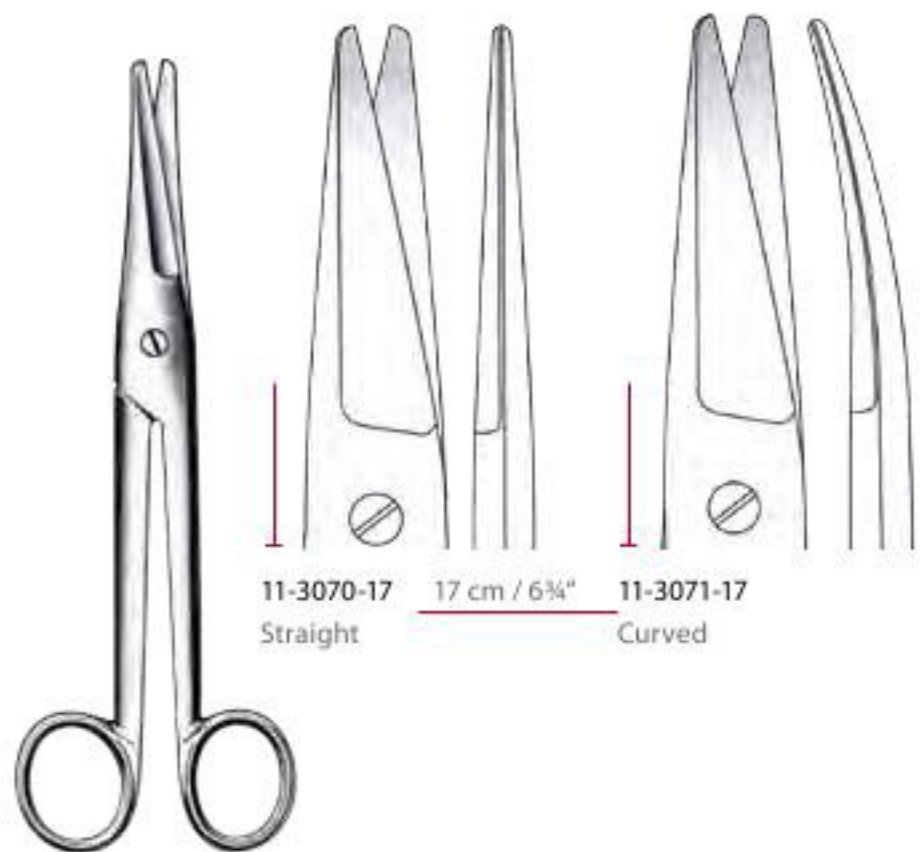

SCISSORS

Metzenbaum

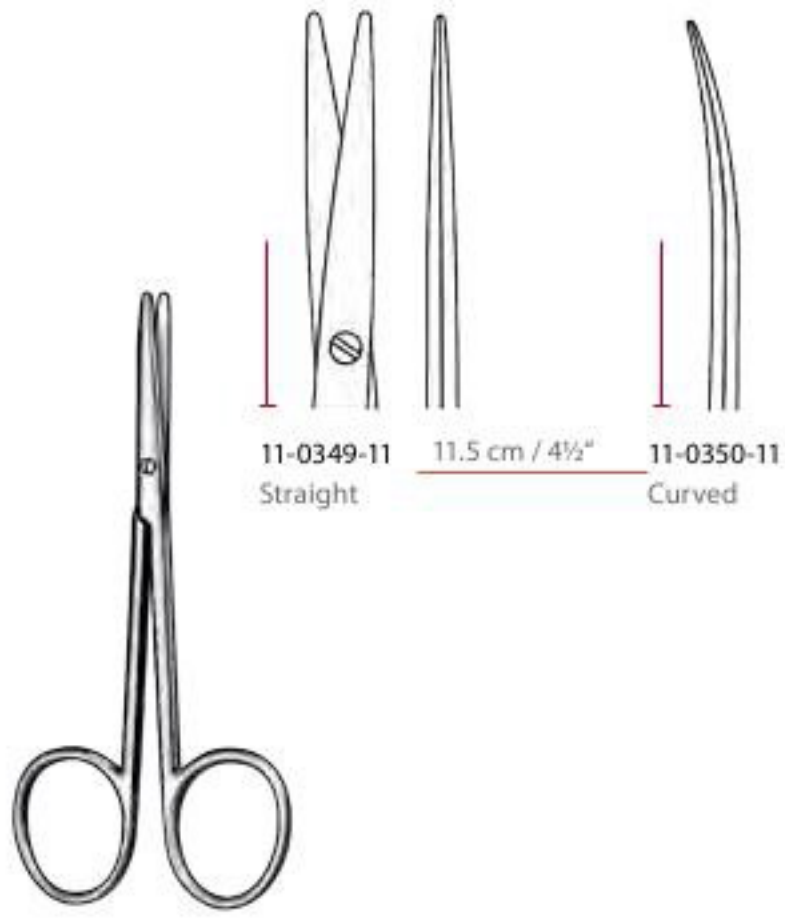

Metzenbaum

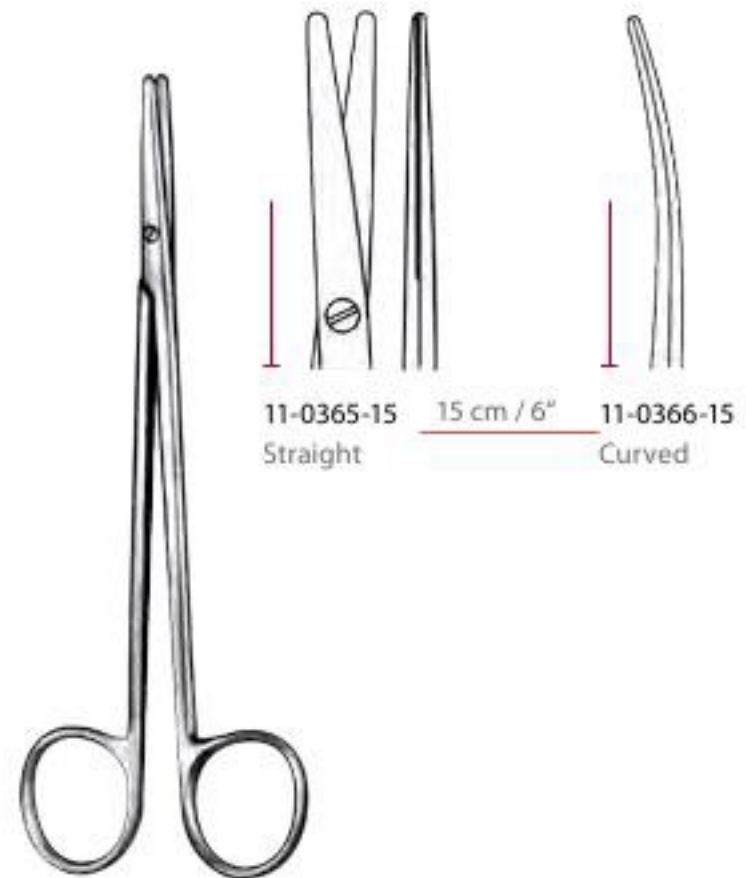

Metzenbaum



Metzenbaum

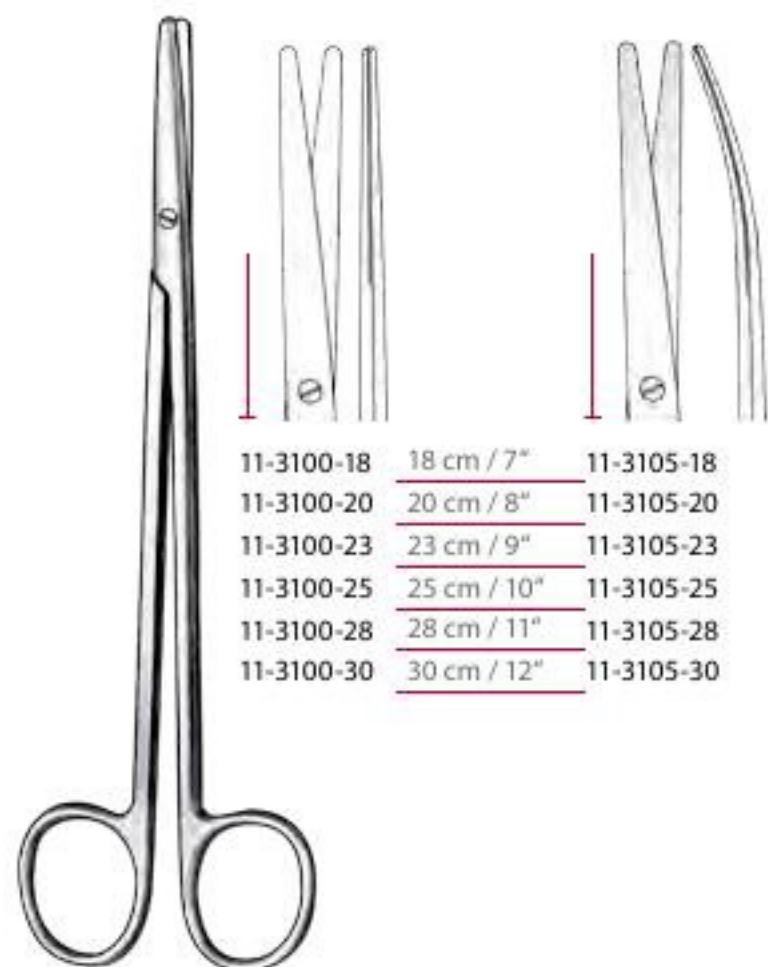

Metzenbaum-Nelson



11-3110-18	18 cm / 7"
11-3110-20	20 cm / 8"
11-3110-23	23 cm / 9"
11-3110-25	25 cm / 10"
11-3110-28	28 cm / 11"
11-3110-30	30 cm / 12"

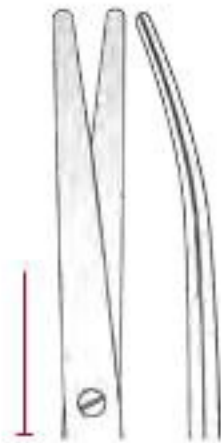

11-3115-18	18 cm / 7"
11-3115-20	20 cm / 8"
11-3115-23	23 cm / 9"
11-3115-25	25 cm / 10"
11-3115-28	28 cm / 11"
11-3115-30	30 cm / 12"



11-3120-18	18 cm / 7"
11-3120-20	20 cm / 8"
11-3120-23	23 cm / 9"
11-3120-25	25 cm / 10"
11-3120-28	28 cm / 11"
11-3120-30	30 cm / 12"

Metzenbaum-Nelson



11-3125-18	18 cm / 7"
11-3125-20	20 cm / 8"
11-3125-23	23 cm / 9"
11-3125-25	25 cm / 10"
11-3125-28	28 cm / 11"
11-3125-30	30 cm / 12"

Lexer



11-3130-16	16 cm / 6¼"
11-3130-21	21 cm / 8½"

Straight



11-3135-16	16 cm / 6¼"
11-3135-21	21 cm / 8½"

Curved



11-3135-16	16 cm / 6¼"
11-3135-21	21 cm / 8½"

SCISSORS

Metzenbaum-Fino



11-0427-14
11-0427-18
11-0427-20
11-0427-23
Slender pattern

14.5 cm / 5½"
18 cm / 7"
20 cm / 8"
23 cm / 9"

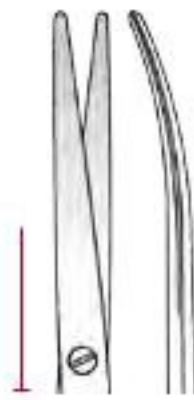

11-0428-14
11-0428-18
11-0428-20
11-0428-23
Slender pattern

14.5 cm / 5½"
18 cm / 7"
20 cm / 8"
23 cm / 9"



11-0429-14
11-0429-18
11-0429-20
11-0429-23
Slender pattern

14.5 cm / 5½"
18 cm / 7"
20 cm / 8"
23 cm / 9"



11-0430-14
11-0430-18
11-0430-20
11-0430-23
Slender pattern

Lexer-Fino



11-3140-16
Slender pattern



16 cm / 6¼"
Slender pattern

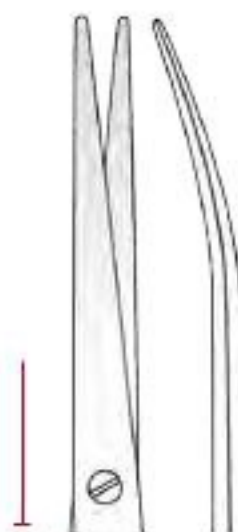

11-3145-16
Slender pattern

Lexer-Baby



11-3150-10
Straight



10 cm / 4"
Curved



11-3151-10
Curved

Iris-Fine



11-3345-11	<u>11 cm / 4½"</u>	11-3346-11
Straight		Curved



11-3350-09	<u>9 cm / 3½"</u>	11-3355-09
11-3350-10	<u>10.5 cm / 4¼"</u>	11-3355-10
Straight Flat		Curved Flat
11-3351-09	<u>9 cm / 3½"</u>	11-3356-09
11-3351-10	<u>10.5 cm / 4¼"</u>	11-3356-10
Straight Round		Curved Round

Iris

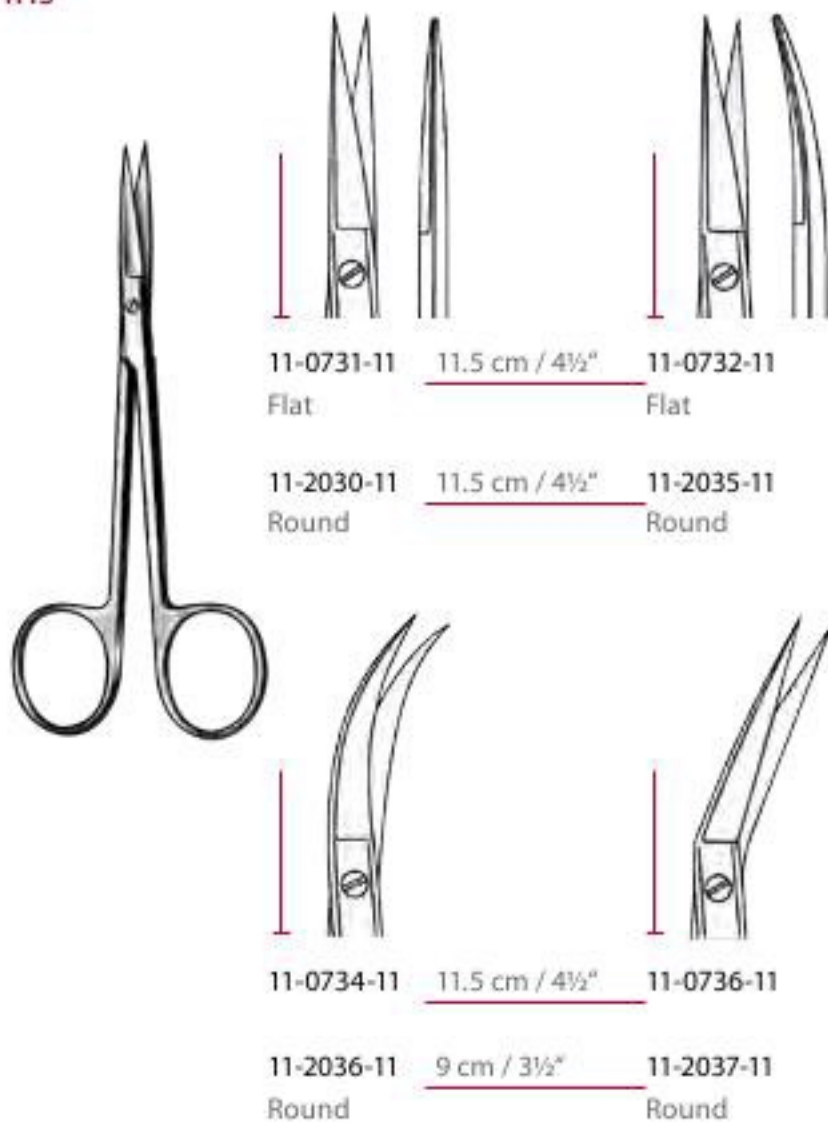

11-0731-11	<u>11.5 cm / 4½"</u>	11-0732-11
Flat		Flat

11-2030-11	<u>11.5 cm / 4½"</u>	11-2035-11
Round		Round

11-0734-11	<u>11.5 cm / 4½"</u>	11-0736-11
------------	----------------------	------------

11-2036-11	<u>9 cm / 3½"</u>	11-2037-11
Round		Round

Stevens

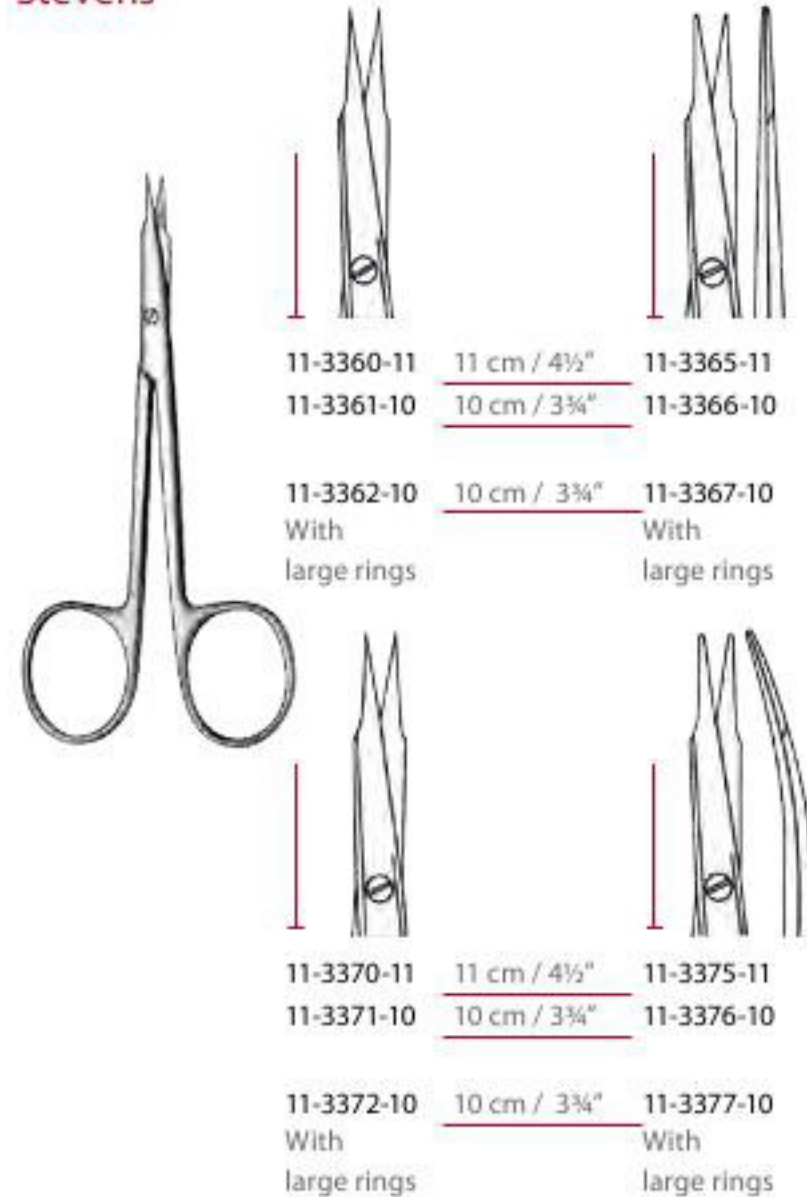

11-3360-11	<u>11 cm / 4½"</u>	11-3365-11
11-3361-10	<u>10 cm / 3¾"</u>	11-3366-10

11-3362-10	<u>10 cm / 3¾"</u>	11-3367-10
With large rings		With large rings

11-3370-11	<u>11 cm / 4½"</u>	11-3375-11
11-3371-10	<u>10 cm / 3¾"</u>	11-3376-10

11-3372-10	<u>10 cm / 3¾"</u>	11-3377-10
With large rings		With large rings

SCISSORS

Strabismus

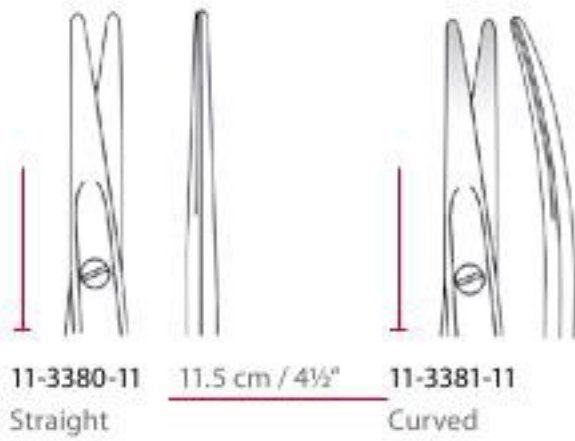

Kilner

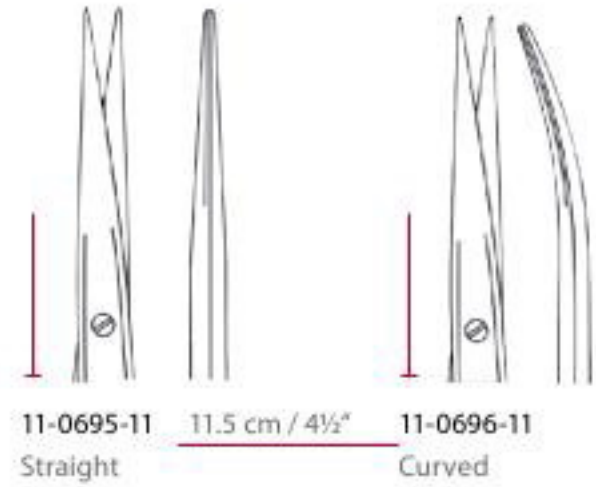

Spencer

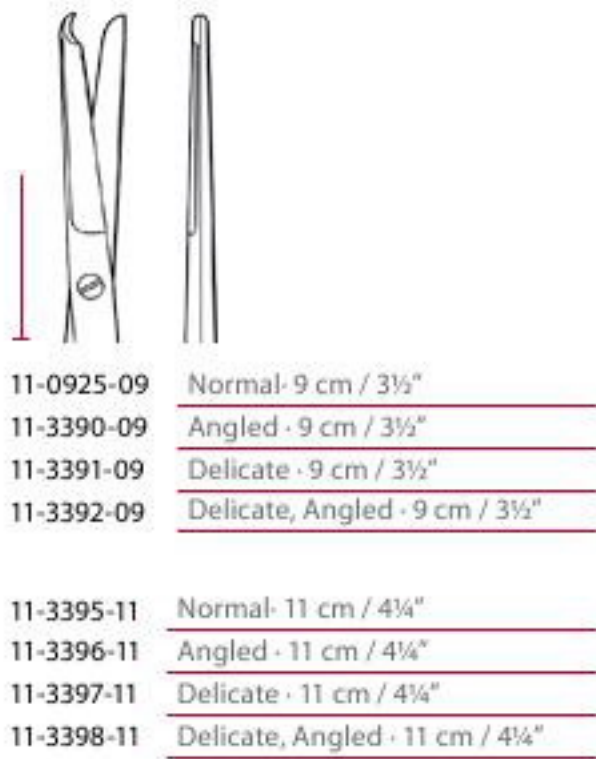
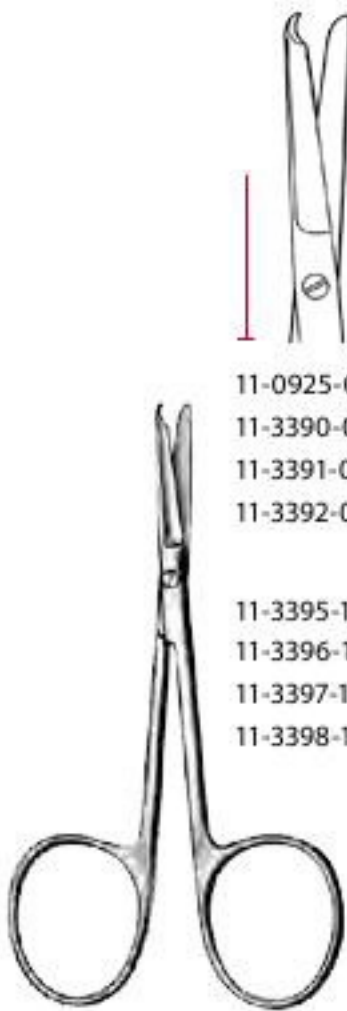

Spencer

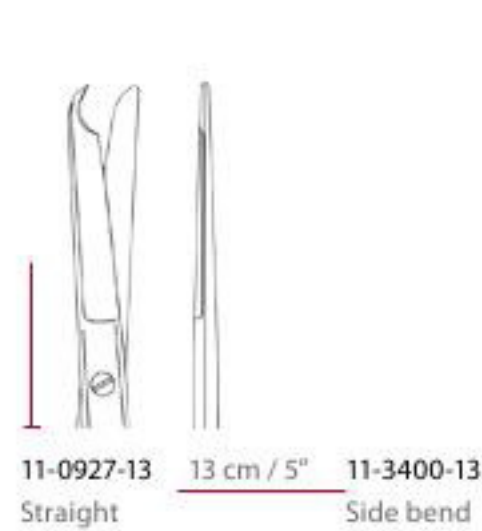

Littauer

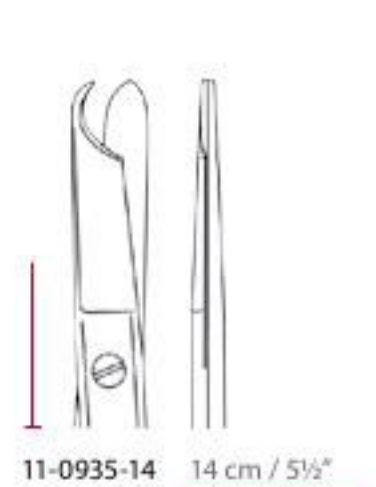

Crown-Beebee



11-0971-10
Straight



10 cm / 4"

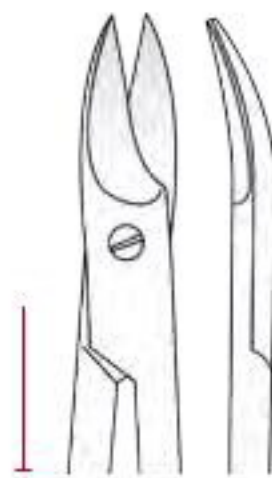

11-0972-10
Curved



11-0975-10
1 Blade
saw edge
Straight



12 cm / 4 3/4"

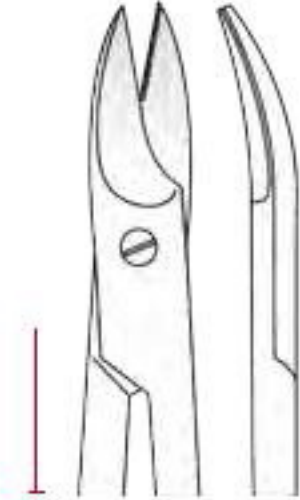

11-0976-10
1 Blade
saw edge
Curved

Universal



11-0966-12
Serrated



12 cm / 4 3/4"

Locklin

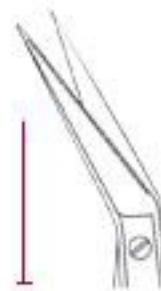

11-0708-16

16 cm / 6 1/4"

Locklin

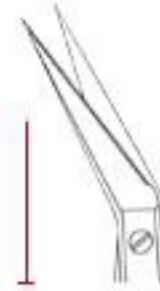

11-0706-16

16 cm / 6 1/4"

MICRO SCISSORS

Westcott





- 21-2001-14 Black · 14.5 cm / 5¾"
- 21-2002-14 Red · 14.5 cm / 5¾"
- 21-2003-14 Blue · 14.5 cm / 5¾"
- 21-2004-14 Yellow · 14.5 cm / 5¾"
- 21-2005-14 Orange · 14.5 cm / 5¾"
- 21-2006-14 Bright pink · 14.5 cm / 5¾"



- 21-0310-18 Black · 18 cm / 7"
- 21-2010-18 Red · 18 cm / 7"
- 21-2011-18 Blue · 18 cm / 7"
- 21-2012-18 Yellow · 18 cm / 7"
- 21-2013-18 Orange · 18 cm / 7"
- 21-2014-18 Bright pink · 18 cm / 7"

Knowles



- 21-0261-14 14 cm / 5½" 21-2020-14
- Straight Angled

Lister / Lister TC

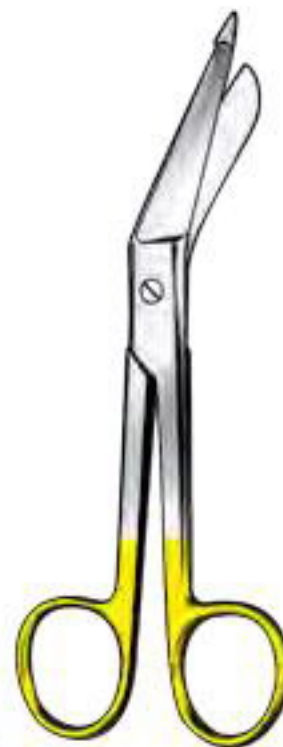

- | | | |
|------------|--------------------|-------------|
| | | TC |
| 21-0266-09 | <u>9 cm / 3½"</u> | 11-3570-09T |
| 21-0266-11 | <u>11 cm / 4½"</u> | 11-3570-11T |
| 21-0266-14 | <u>14 cm / 5½"</u> | 11-3570-14T |
| 21-0266-16 | <u>16 cm / 6¼"</u> | 11-3570-16T |
| 21-0266-18 | <u>18 cm / 7"</u> | 11-3570-18T |
| 21-0266-20 | <u>20 cm / 8"</u> | 11-3570-20T |
| without TC | | with TC |

SCISSORS. with Tungsten Carbide Inserts

Standard, TC

	<p>11-3580-14T <u>14.5 cm / 5¾"</u> 11-3585-14T</p> <p>11-3580-16T <u>16 cm / 6¼"</u> 11-3585-16T</p> <p>11-3580-18T <u>18 cm / 7"</u> 11-3585-18T</p>	<p>11-3585-14T</p> <p>11-3585-16T</p> <p>11-3585-18T</p>
	<p>Straight</p>	<p>Curved</p>

Standard, TC

	<p>11-3590-14T <u>14.5 cm / 5¾"</u> 11-3595-14T</p> <p>11-3590-16T <u>16 cm / 6¼"</u> 11-3595-16T</p> <p>11-3590-18T <u>18 cm / 7"</u> 11-3595-18T</p>	<p>11-3595-14T</p> <p>11-3595-16T</p> <p>11-3595-18T</p>
	<p>Straight</p>	<p>Curved</p>

Standard, TC

	<p>11-3600-14T <u>14.5 cm / 5¾"</u> 11-3605-14T</p> <p>11-3600-16T <u>16 cm / 6¼"</u> 11-3605-16T</p> <p>11-3600-18T <u>18 cm / 7"</u> 11-3605-18T</p>	<p>11-3605-14T</p> <p>11-3605-16T</p> <p>11-3605-18T</p>
	<p>Straight</p>	<p>Curved</p>

Mayo, TC

	<p>11-3610-14T <u>14.5 cm / 5¾"</u> 11-3615-14T</p> <p>11-3610-17T <u>17 cm / 6¾"</u> 11-3615-17T</p> <p>11-3610-23T <u>23 cm / 9"</u> 11-3615-23T</p>	<p>11-3615-14T</p> <p>11-3615-17T</p> <p>11-3615-23T</p>
	<p>Straight</p>	<p>Curved</p>

Mayo-Stille, TC

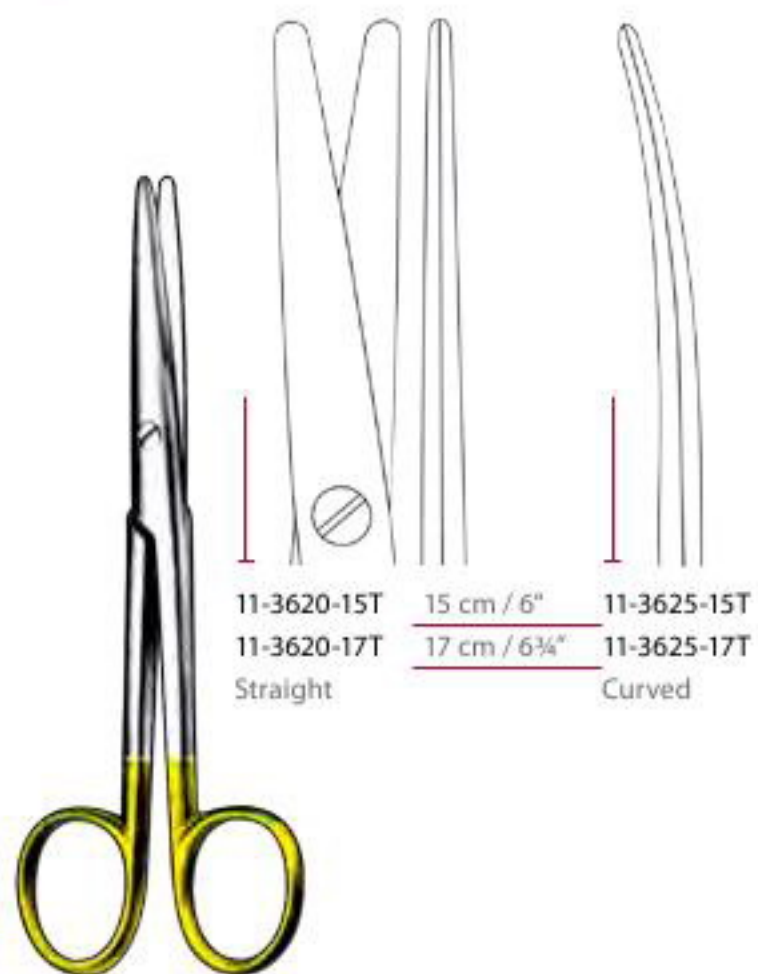

Lexer, TC



Mayo-Lexer, TC



Metzenbaum, TC



SCISSORS. with Tungsten Carbide Inserts

Metzenbaum , TC

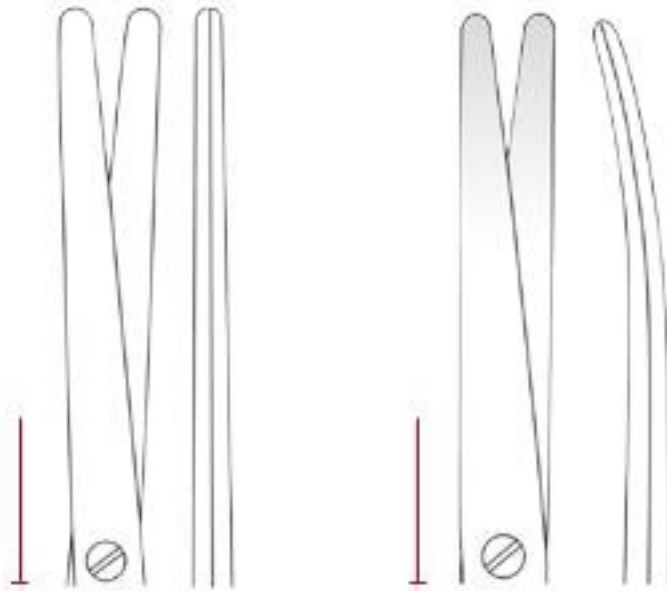

11-3655-14T	14.5 cm / 5¾"	11-3660-14T
11-3655-18T	18 cm / 7"	11-3660-18T
11-3655-20T	20 cm / 8"	11-3660-20T
11-3655-23T	23 cm / 9"	11-3660-23T
11-3655-25T	25 cm / 10"	11-3660-25T
11-3655-28T	28 cm / 11"	11-3660-28T
11-3655-30T	30 cm / 12"	11-3660-30T
Straight		Curved

Metzenbaum- Fino , TC

Delicate
Standard

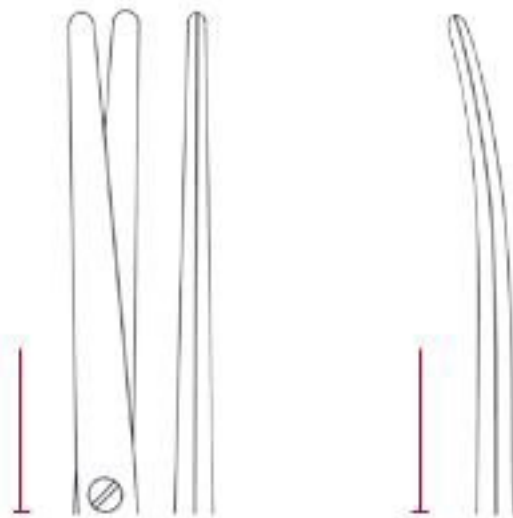

11-1055-14T	14.5 cm / 5¾"	11-1056-14T
11-1055-18T	18 cm / 7"	11-1056-18T
11-1055-20T	20 cm / 8"	11-1056-20T
11-1055-23T	23 cm / 9"	11-1056-23T
11-1055-25T	25 cm / 10"	11-1056-25T
11-1055-28T	28 cm / 11"	11-1056-28T
11-1055-30T	30 cm / 12"	11-1056-30T
Straight		Curved

Metzenbaum-Lahey, TC



Iris, TC



Iris, TC

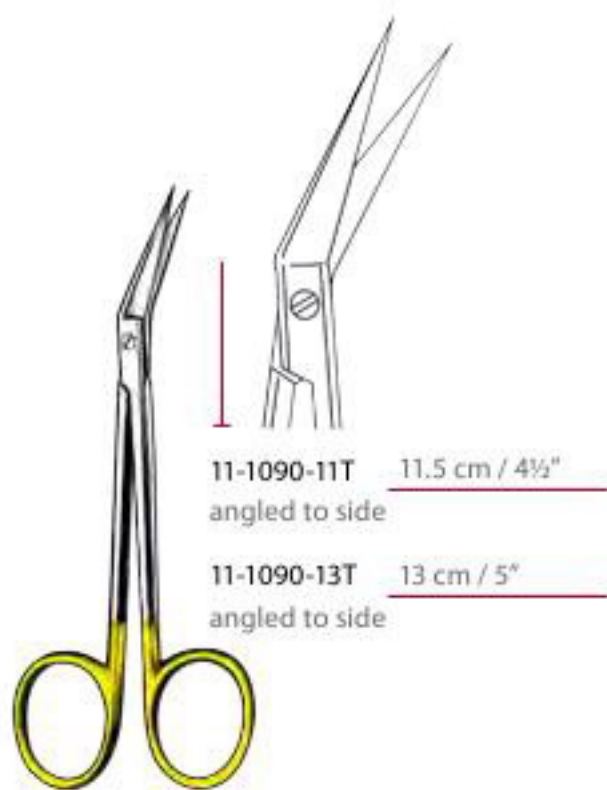

Goldman-Fox, TC



Ragnell (Kilner), TC



Crile-Murray



20-0449-15 15 cm / 6"

Crile-Wood

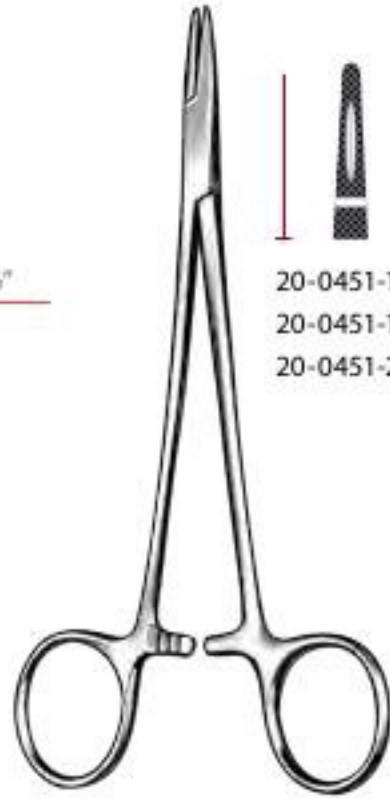

20-0451-15 15 cm / 6"
 20-0451-18 18 cm / 7"
 20-0451-20 20 cm / 8"

Mayo-Hegar
Delicate



20-0497-16 16 cm / 6¼"

20-0497-18 18 cm / 7"

20-0497-20 20 cm / 8"

Mayo-Hegar

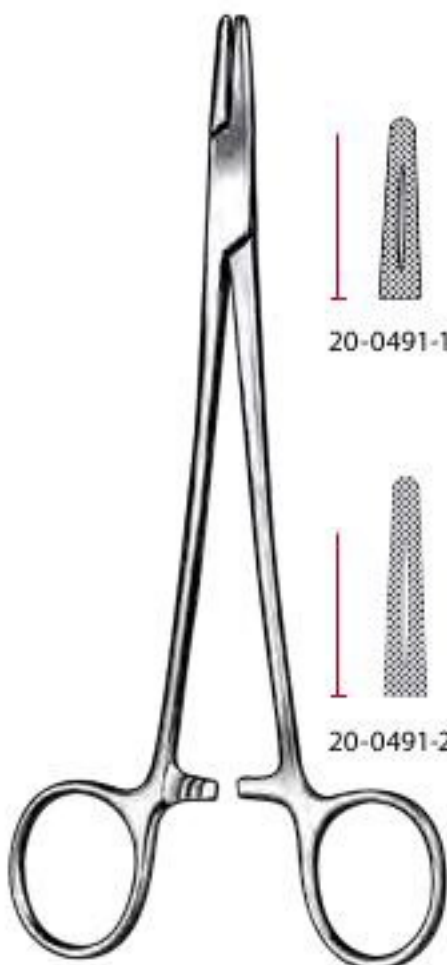

20-0491-14 14 cm / 5½"
 20-0491-16 16 cm / 6¼"

20-0491-18 18 cm / 7"
 20-0491-20 20 cm / 8"

20-0491-24 24 cm / 9½"
 20-0491-26 26 cm / 10¼"

Adson



20-0461-18 18 cm / 7"

Metzenbaum



20-0465-18 18 cm / 7"

NEEDLE HOLDERS

Mathieu

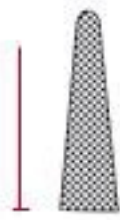

20-0617-14
20-0617-16
20-0617-17
20-0617-20
20-0617-24

14 cm / 5½"
16 cm / 6¼"
17 cm / 6¾"
20 cm / 8"
24 cm / 9½"

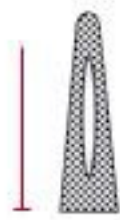

20-2035-14
20-2035-16
20-2035-17
20-2035-20
20-2035-24

Mathieu



20-0627-14
Slender jaws



14 cm / 5½"

Olsen-Hegar

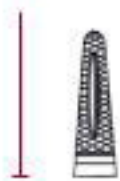

20-0565-12
20-0565-14
20-0565-16
20-0565-18

12 cm / 4¾", Mini
14 cm / 5½"
16 cm / 6¼"
18 cm / 7"

Gillies



20-0570-16
Serrated jaws

16 cm / 6¼"

McPherson



Castroviejo
Without lock



Castroviejo
With lock

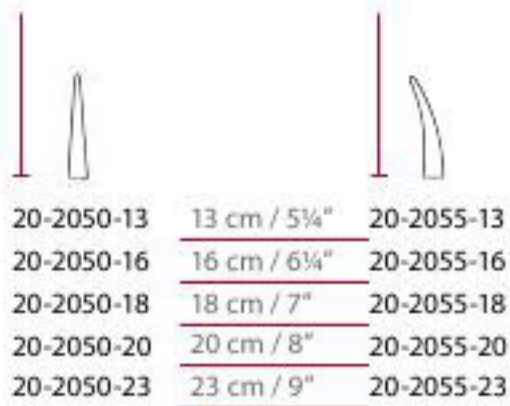

Castroviejo
Extra delicate,
with lock



NEEDLE HOLDERS. with Tungsten Carbide Inserts

Derf, TC

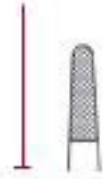

0,4
20-0733-12T
Mini profile
12 cm / 4¾"

Webster, TC



20-0738-12T
Smooth
12 cm / 4¾"



20-2070-12T
Serrated

Kilner, TC

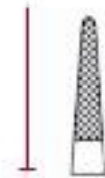

0,5
20-0732-13T
Normal profile
13,5 cm / 5¼"

**Webster, TC
Delicate**

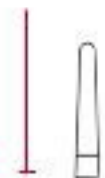
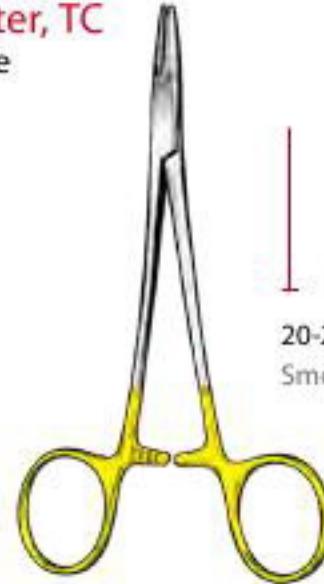

20-2073-13T
Smooth
12 cm / 4¾"

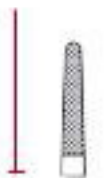

20-2075-13T
Serrated

Halsey, TC

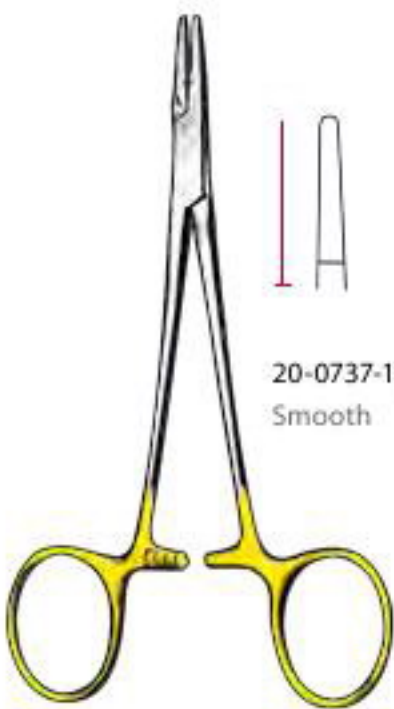

20-0737-13T
Smooth



0,4
20-0738-13T
Serrated
Mini profile
13 cm / 5"

Hegar-Baumgartner, TC

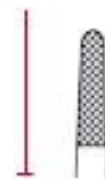
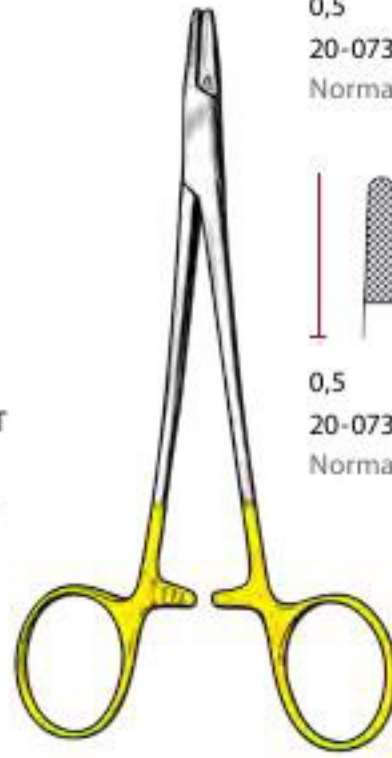

0,5
20-0735-13T
Normal profile
13 cm / 5"

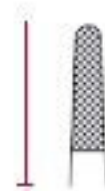

0,5
20-0735-14T
Normal profile
14 cm / 5½"

Crile-Wood, TC



0,4
20-0705-13T
Mini profile

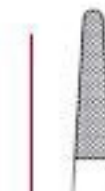

0,4
20-0705-15T
Mini profile

With automatic release ratchet

NEEDLE HOLDERS. with Tungsten Carbide Inserts

Crile-Wood, TC

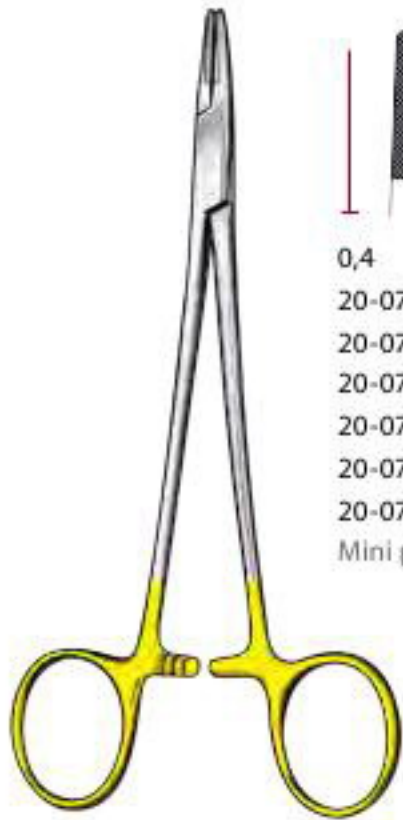

0,4	
20-0739-15T	15 cm / 6"
20-0739-18T	18 cm / 7"
20-0739-20T	20 cm / 8"
20-0739-23T	23 cm / 9"
20-0739-25T	25 cm / 10"
20-0739-30T	30 cm / 12"
Mini profile	

Mayo-Hegar, TC

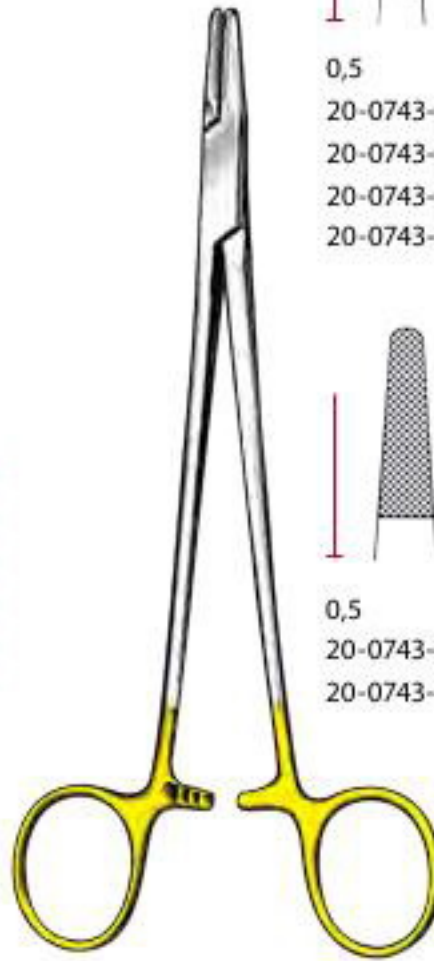

0,5	
20-0743-14T	14 cm / 5 1/4"
20-0743-16T	16 cm / 6 1/4"
20-0743-18T	18 cm / 7"
20-0743-20T	20 cm / 8"



0,5	
20-0743-35T	35 cm / 14"
20-0743-45T	45 cm / 18"

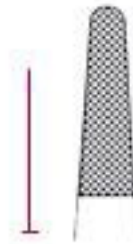

0,5	
20-0743-24T	24 cm / 9 1/2"
20-0743-26T	26 cm / 10 1/4"
20-0743-30T	30 cm / 12"

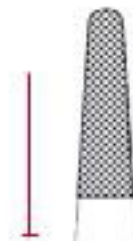

0,5	
20-0743-40T	40 cm / 16"
Normal profile	

Olsen-Hegar, TC

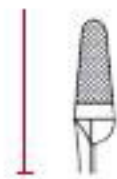

0,2	
20-3155-12T	12 cm / 4 3/4"
Micro profile	

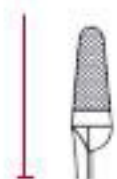

0,4	
20-0773-14T	14 cm / 5 1/2"
20-0773-16T	16 cm / 6 1/4"
20-0773-17T	17 cm / 6 1/2"
20-0773-19T	19 cm / 7 1/2"
Mini profile	

De Bakey, TC



0,4	
20-0747-18T	18 cm / 7"
20-0747-20T	20 cm / 8"
20-0747-23T	23 cm / 9"

NEEDLE HOLDERS. with Tungsten Carbide Inserts

McPherson, TC

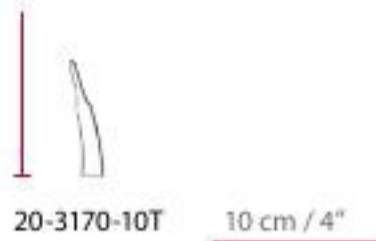

Castroviejo, TC Without lock



Castroviejo, TC With lock

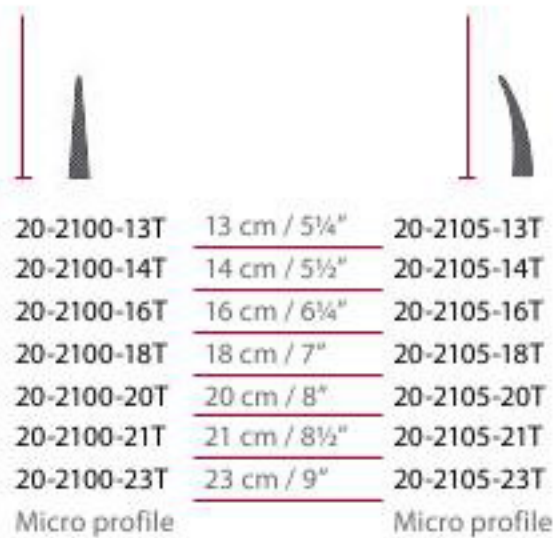
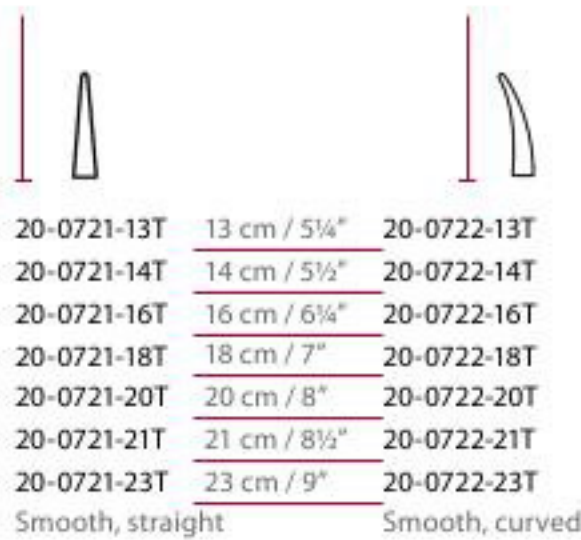

Castroviejo, TC Extra delicate, with lock



Farabeuf
Set of 2

Fig. 2 30 x 10 mm
Fig. 1 26 x 10 mm

Fig. 2 30 x 13 mm
Fig. 1 34 x 13 mm



15-0764-00 12 cm / 4 $\frac{1}{4}$ "

Farabeuf
Set of 2

Fig. 2 27 x 16 mm
Fig. 1 23 x 16 mm

Fig. 2 26 x 16 mm
Fig. 1 30 x 16 mm



15-0766-00 15 cm / 6"

Collin
Set of 2

Fig. 2 21 x 14 mm
Fig. 1 17 x 14 mm

Fig. 2 28 x 16 mm
Fig. 1 32 x 16 mm

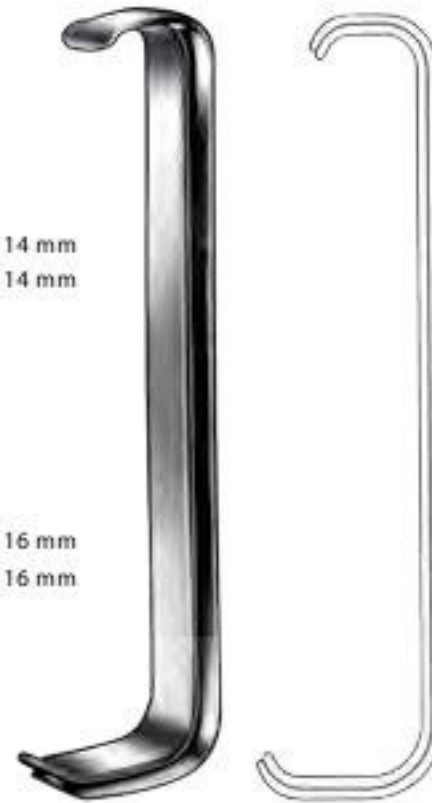
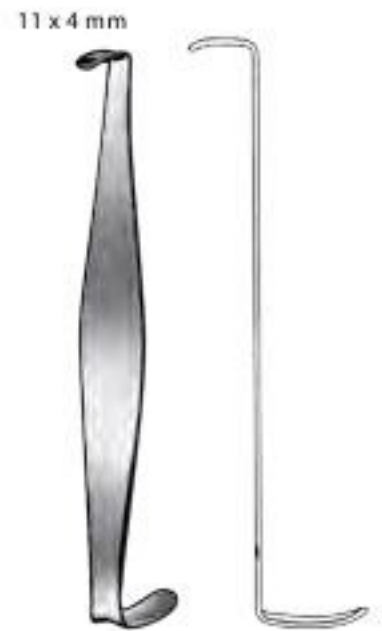

15-3001-15 15 cm / 6"

Crile

11 x 4 mm

19 x 6 mm



15-3005-11 11 cm / 4 $\frac{1}{4}$ "

Mini-Roux

15-0768-06 14 cm / 5 $\frac{1}{2}$ "

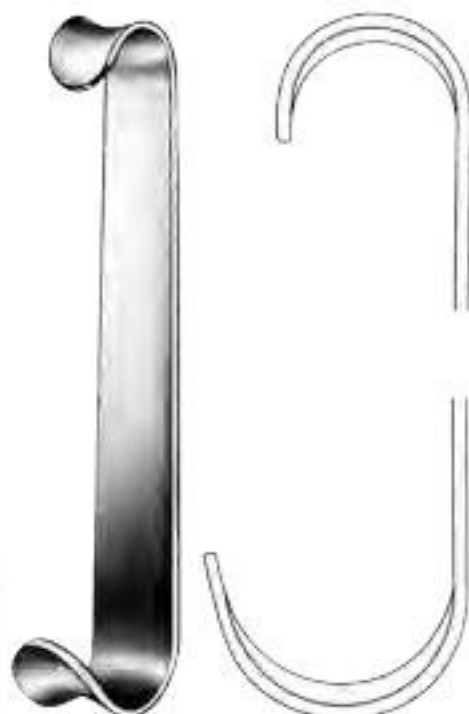
Baby-Roux

15-0770-13 13 cm / 5 $\frac{1}{4}$ "

Roux

15-0756-00	Set
15-0756-01	14 cm / 5 $\frac{1}{2}$ "
15-0756-02	15 cm / 6"
15-0756-03	17 cm / 6 $\frac{3}{4}$ "
15-0756-04	18 cm / 7"

Parker
Set of 2

Fig. 2 22 x 15 mm
Fig. 1 19 x 15 mm

Fig. 2 19 x 15 mm
Fig. 1 22 x 15 mm



15-0774-01

RETRACTORS

Parker
Set of 2

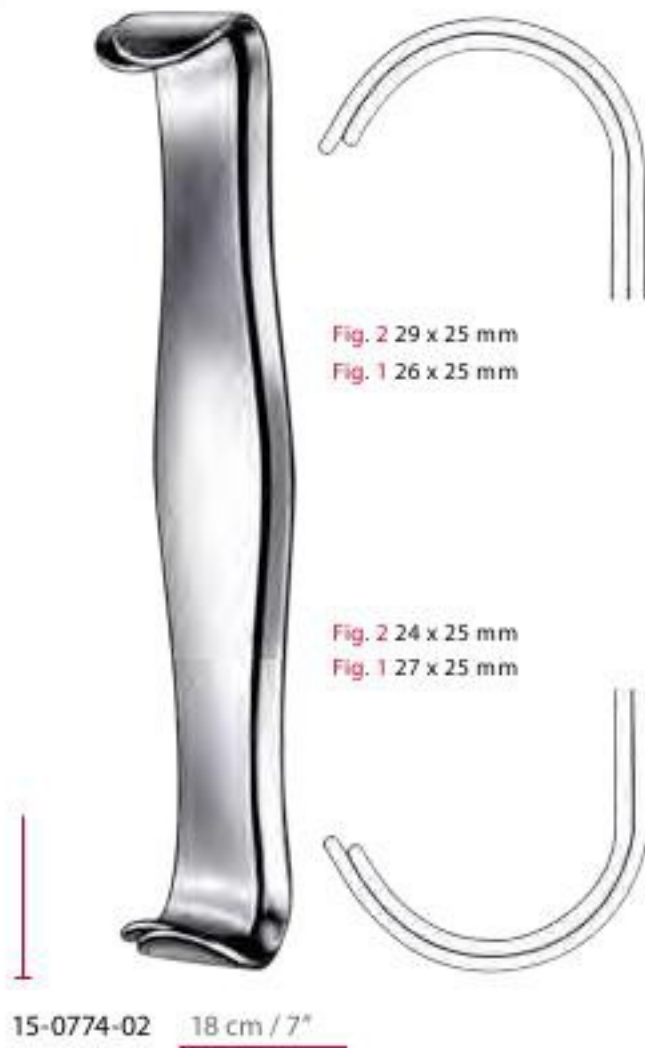

Parker-Motts
Set of 2



Mathieu



Parker-Langenbeck
Set of 2



Skin Hook

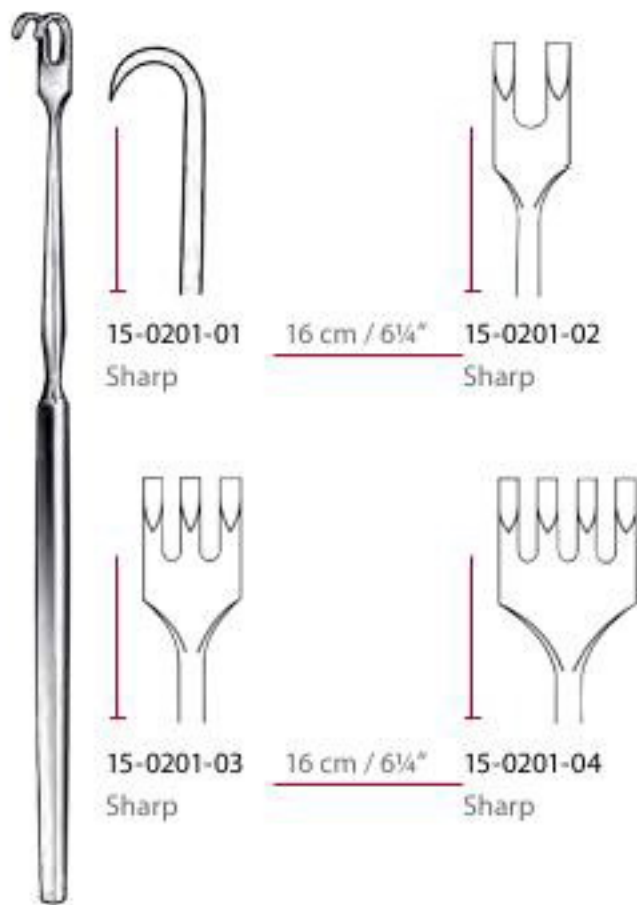

Skin Hook

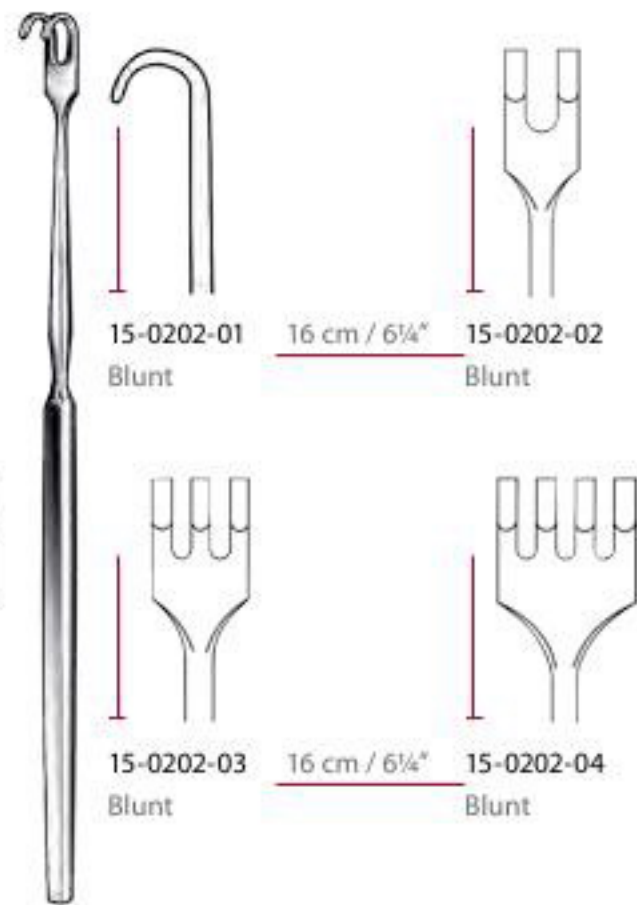

Skin Hook



Skin Hook

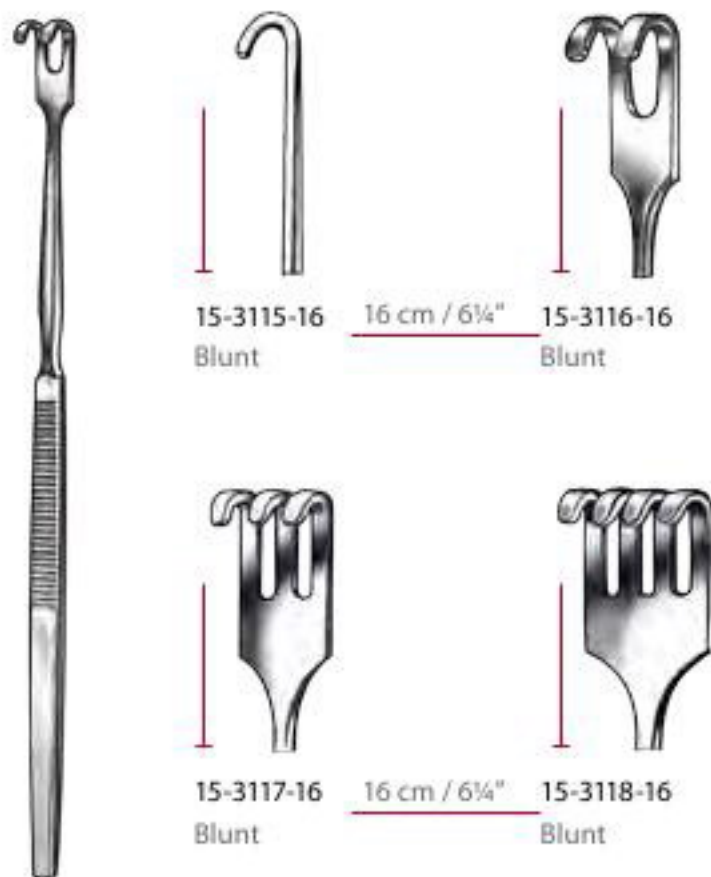

Knapp
Flexible



RETRACTORS

Joseph



Graefe

O'Connor

Guthrie



Desmarres

Langenbeck-Green

Mini-Langenbeck

Cushing

Cushing

RETRACTORS

Ragnell-Davis

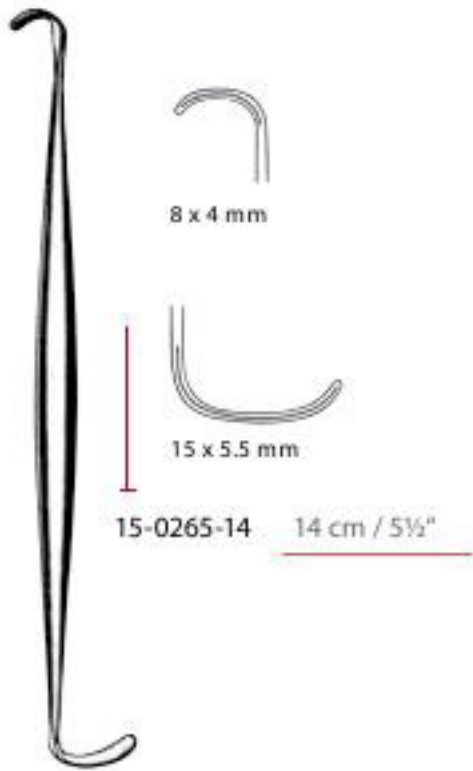

Senn-Green



Senn-Miller

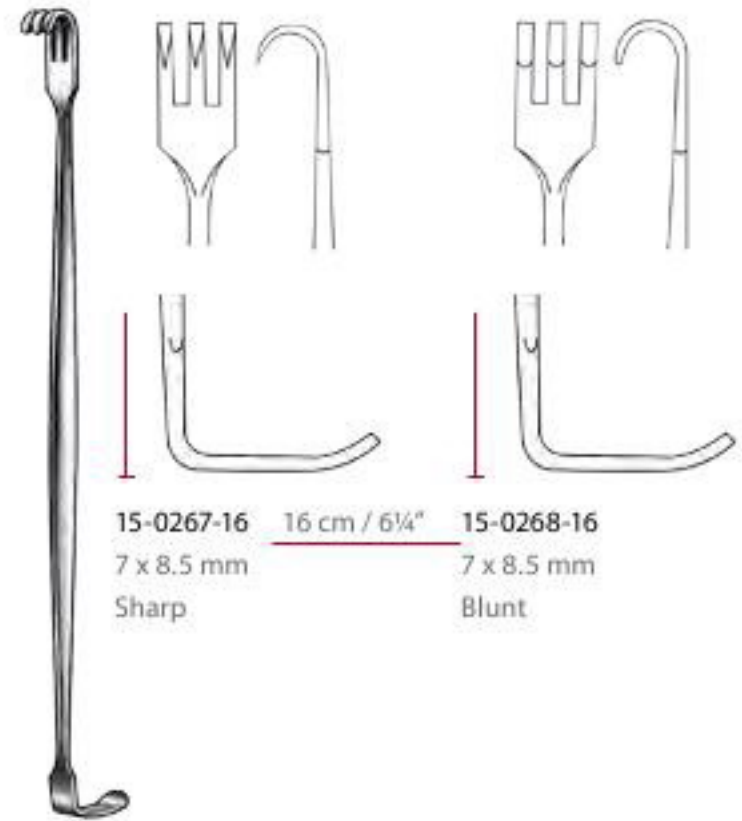

Meyerding

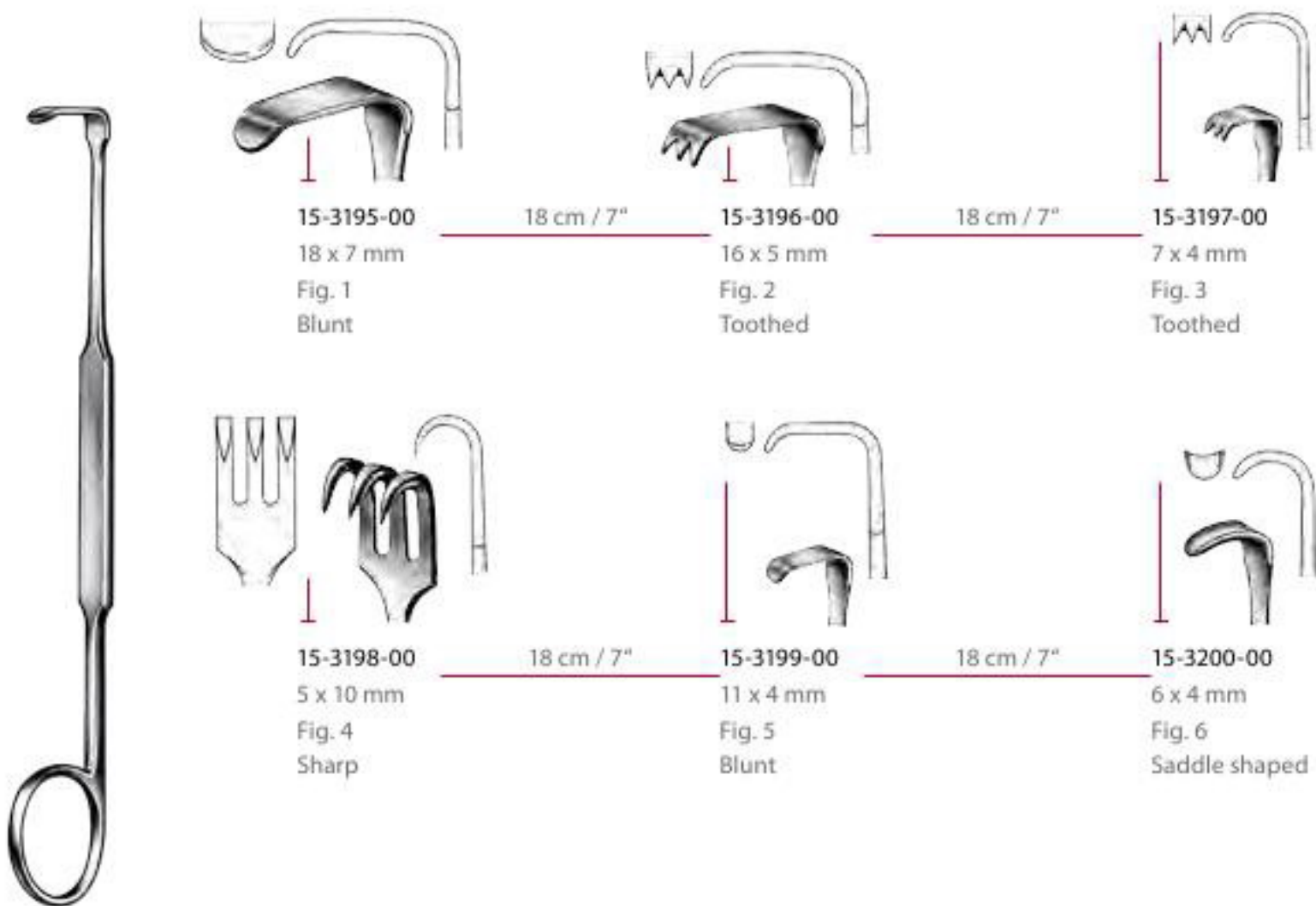

Finsen

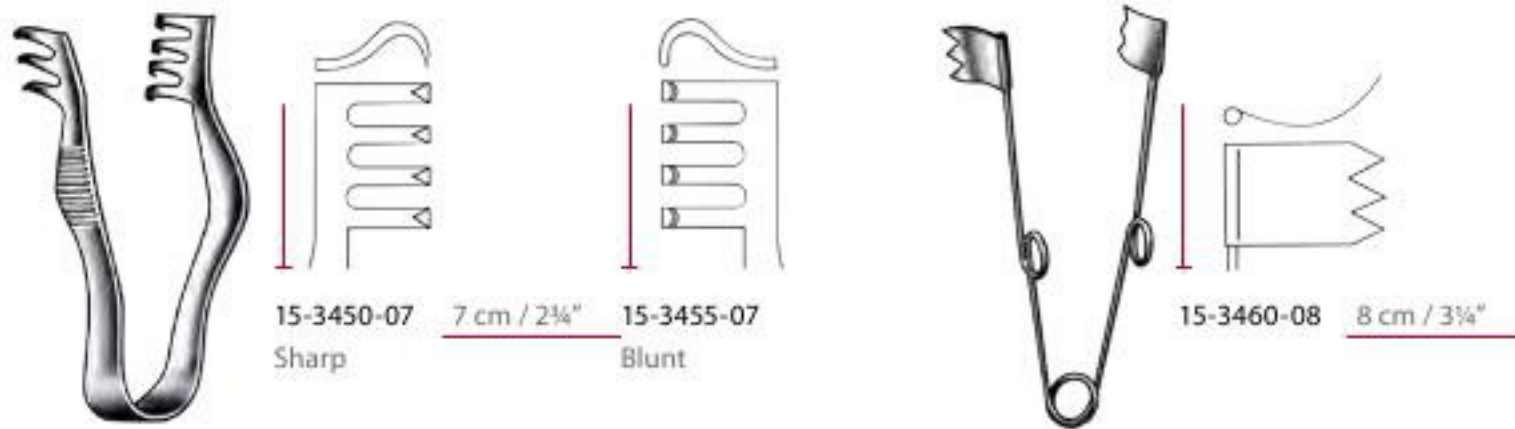

Buckley

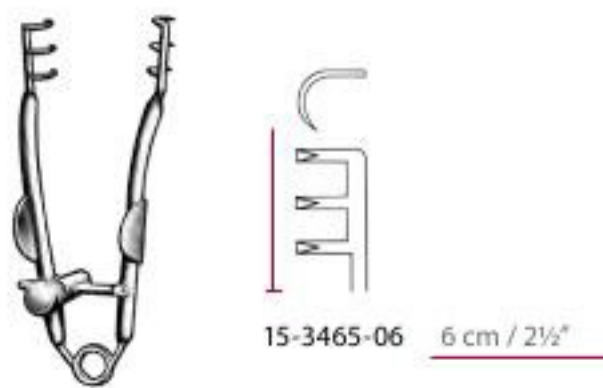

Alm

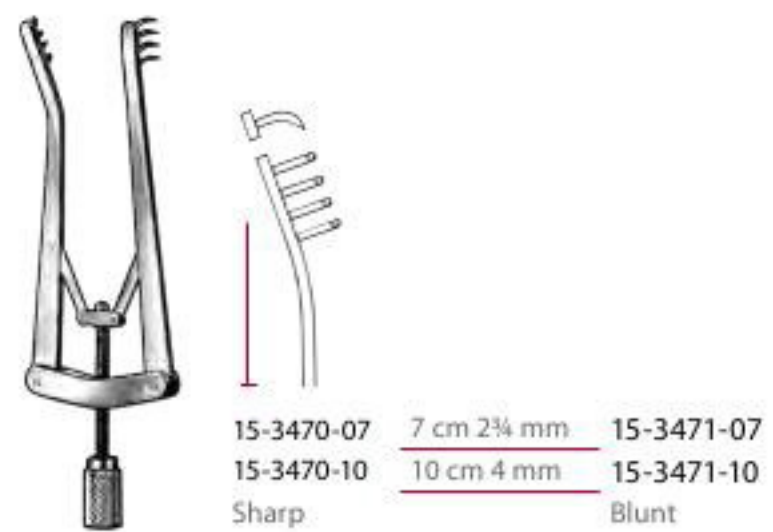

Jansen

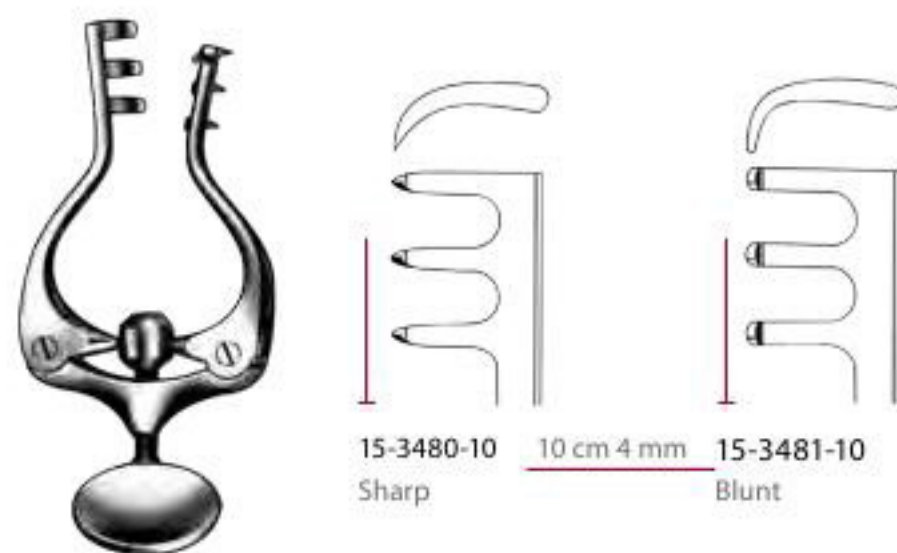

Alm

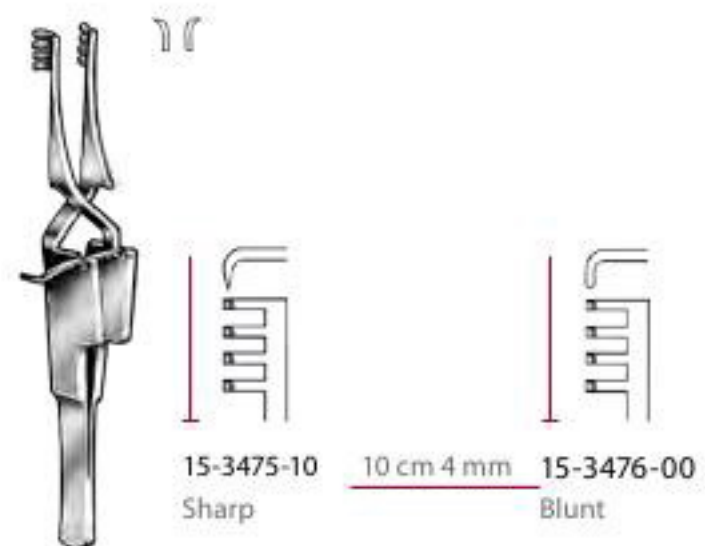

RETRACTORS

Weitlaner



15-3490-10	10.5 cm / 4 1/4"	15-3491-10
Sharp		Blunt
2:3 Teeth		2:3 Teeth

Weitlaner

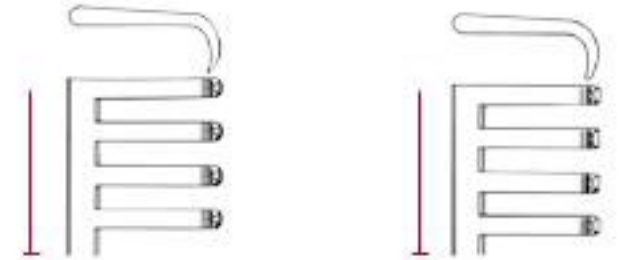

15-3495-14	14 cm / 5 1/2"	15-3496-14
15-3495-16	16.5 cm / 6 1/2"	15-3496-16
15-3495-18	18 cm / 7"	15-3496-18
15-3495-20	20 cm / 8"	15-3496-20
15-3495-24	24.5 cm / 9 1/2"	15-3496-24
Sharp		Blunt
3:4 Teeth		3:4 Teeth

West

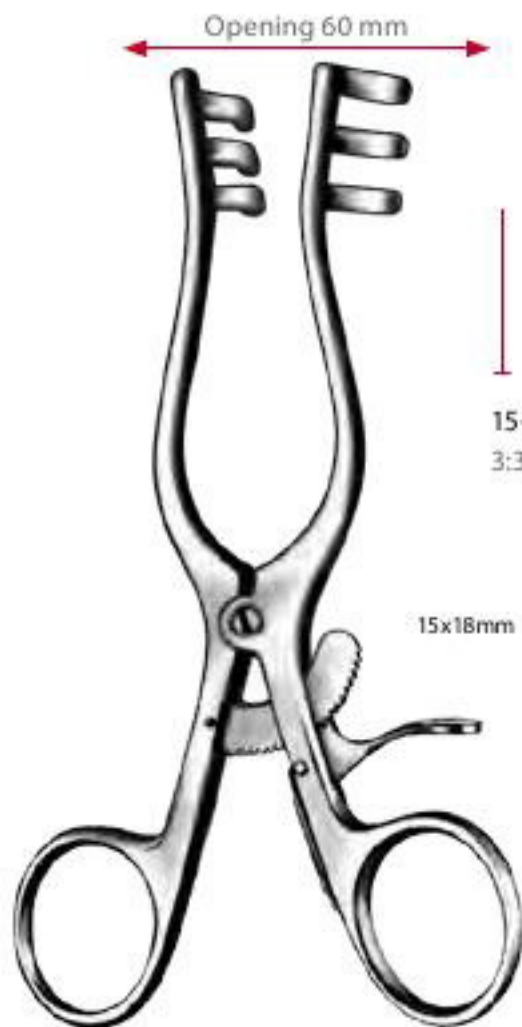

15-3500-13	13 cm / 5 1/4"
3:3 Teeth	

Weitlaner-Wullstein

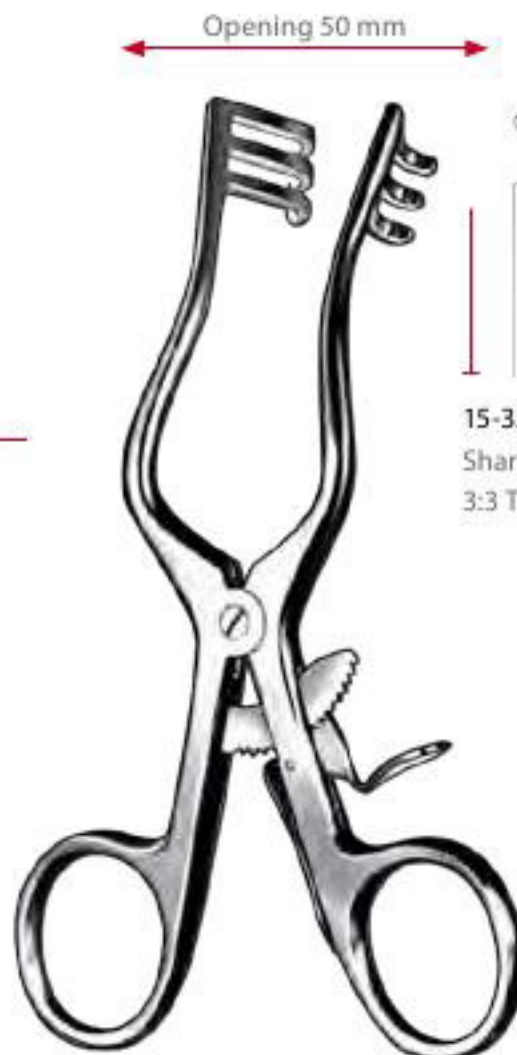

15-3505-14	14 cm / 5 1/2"	15-3506-14
Sharp		Blunt
3:3 Teeth		3:3 Teeth

Weitlaner

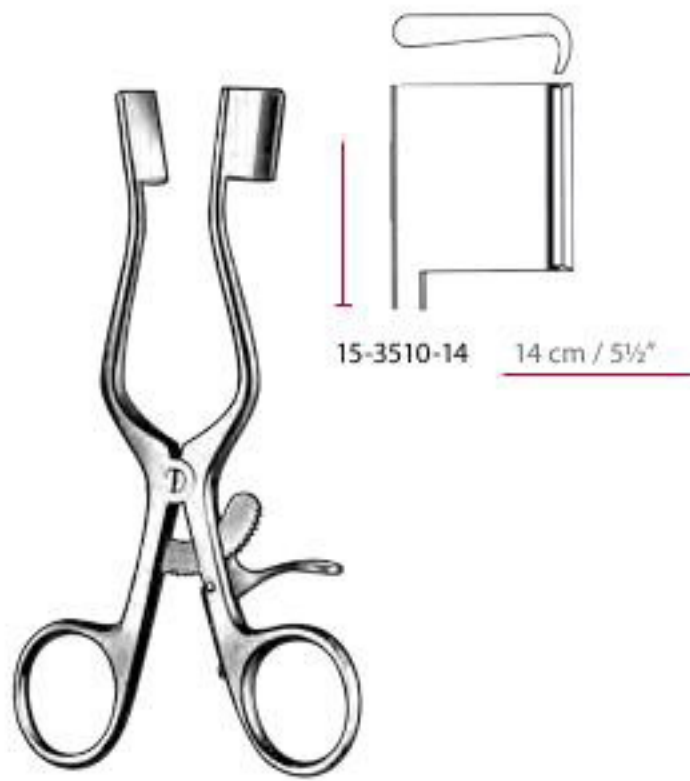

Mollison

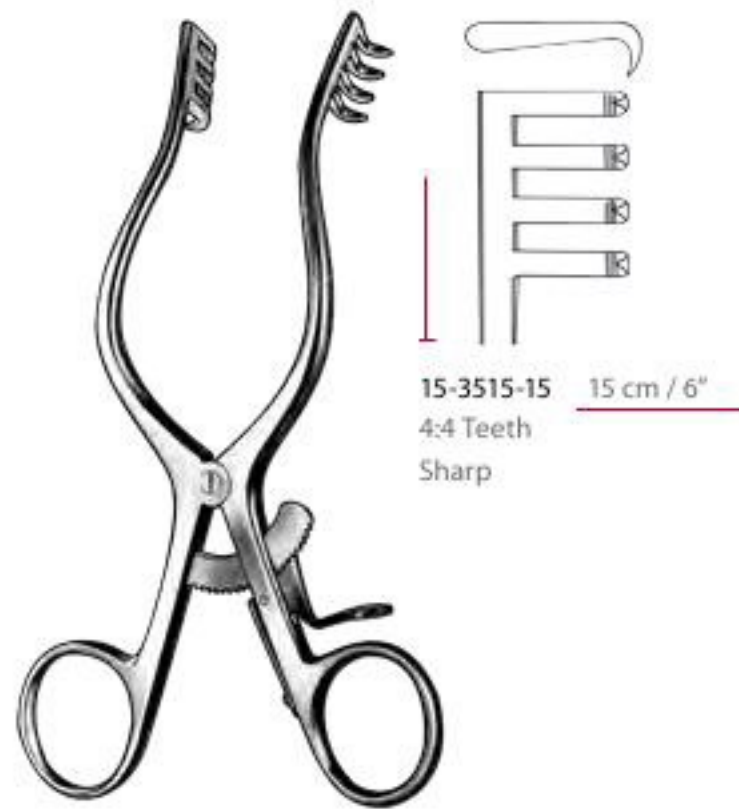

Milligan

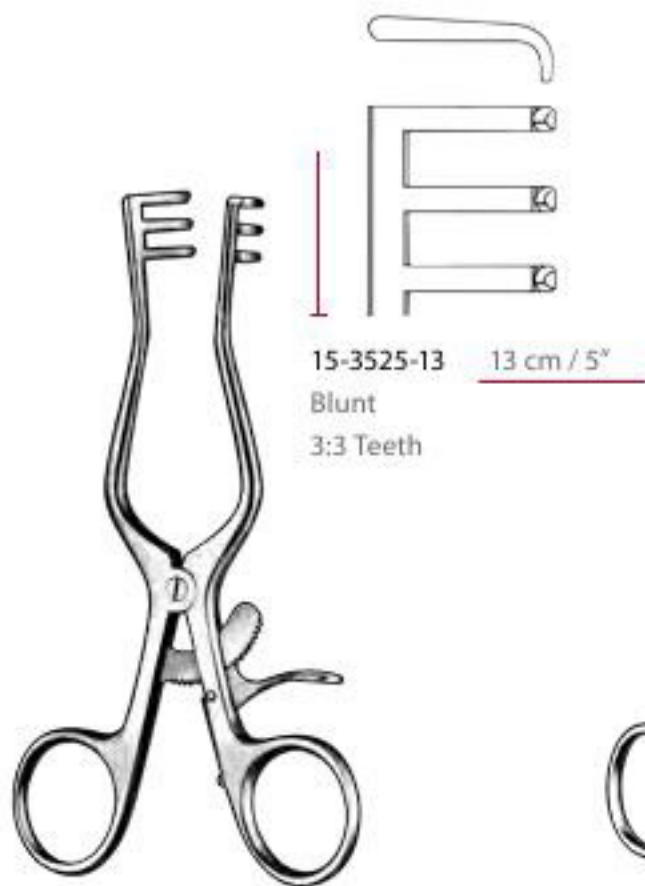

Plester



Plester

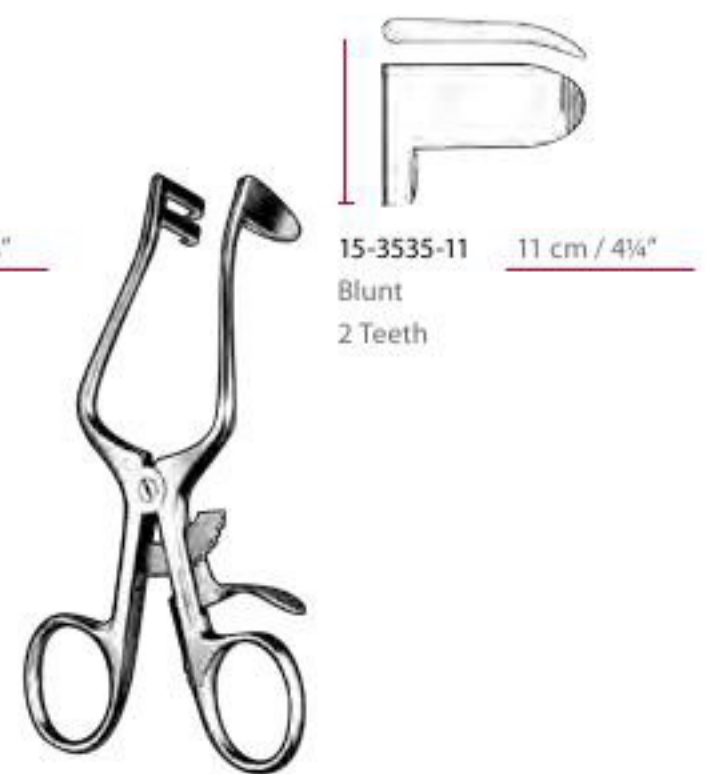

RETRACTORS

Perkins

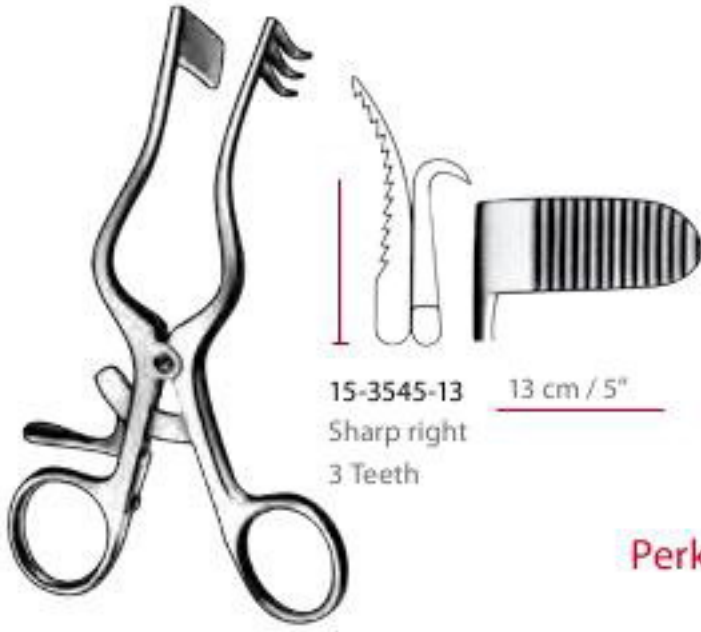

15-3545-13 13 cm / 5"
Sharp right
3 Teeth

Norfolk-Norwich



15-3565-22 22 cm / 8¾"
Blunt
5:4 Teeth

Perkins



15-3550-13 13 cm / 5"
Sharp left
3 Teeth

Gelpi



15-3660-09 9 cm / 3½"
15-3660-11 11.5 cm / 4½"
15-3660-14 14 cm / 5½"
15-3660-16 16 cm / 6¼"
15-3660-18 18 cm / 7"
15-3660-20 20 cm / 8"

Gelpi



15-3665-09 9 cm / 3½"
15-3665-11 11.5 cm / 4½"
15-3665-14 14 cm / 5½"
15-3665-16 16 cm / 6¼"
15-3665-18 18 cm / 7"

Gelpi

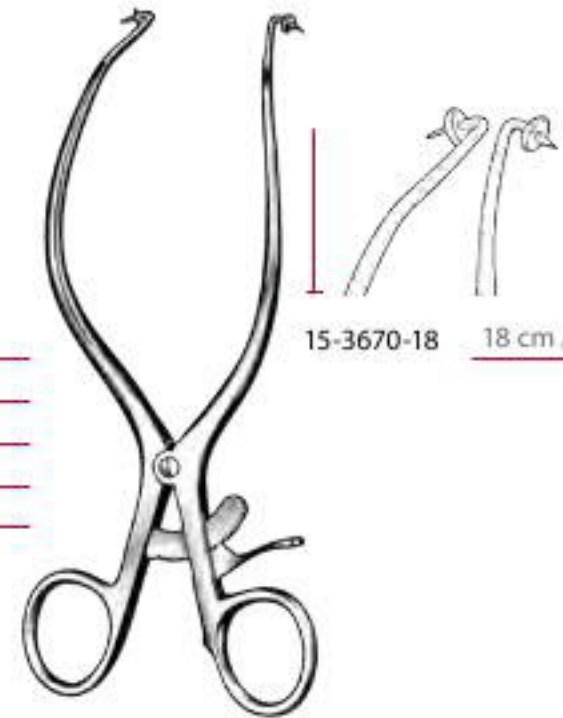

15-3670-18 18 cm / 7"

Balfour-Baby

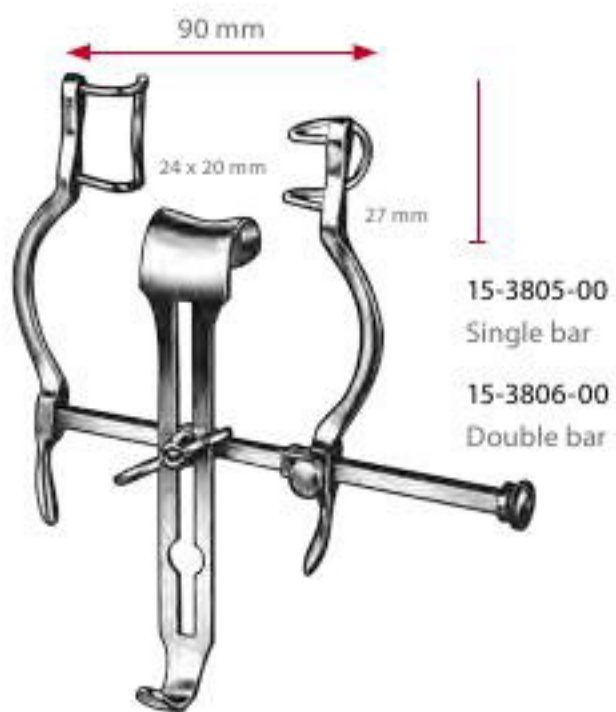

Balfour

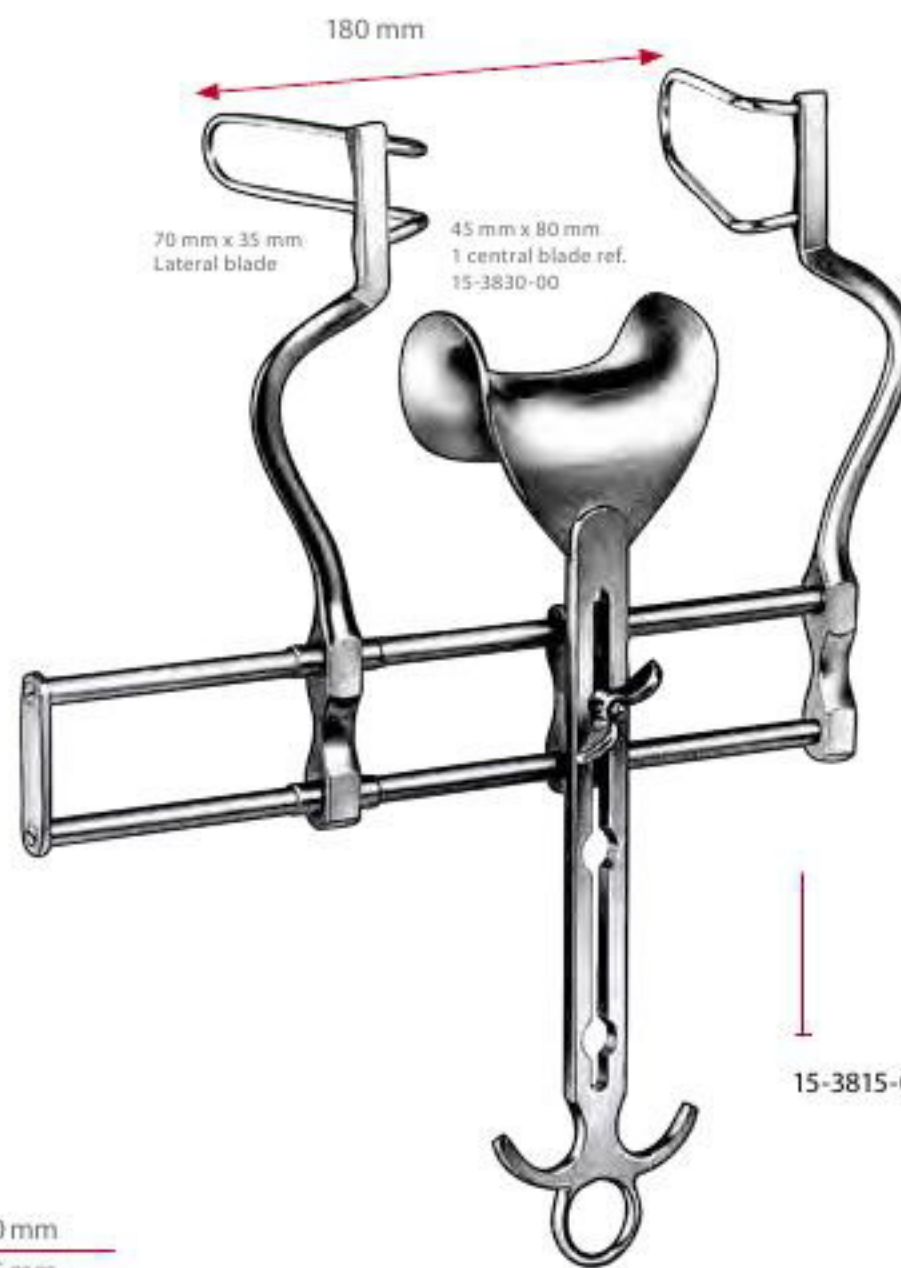

Balfour



ORTHOPEDIC. Mallets

Collin



23-0317-01 16.5 cm / 6½"
140 gm / 5 oz
ø 20 mm

Williger



23-0309-20 20 cm / 8"
220 gm / 7¾ oz
ø 30 mm



23-0301-01 24 cm / 9½"
300 gm / 10½ oz
ø 26 mm



23-0301-02 24 cm / 9½"
340 gm / 12 oz
ø 28 mm



23-0301-03 24 cm / 9½"
400 gm / 14 oz
ø 30 mm

Lucae



23-0315-01 19 cm / 7½"
230 gm / 8 oz
ø 19 mm



23-0315-02 19 cm / 7½"
260 gm / 9 oz
ø 25 mm

Mead



23-3070-17 17 cm / 6¾"
320 gm
ø 26 mm
Solid

23-3071-17 17 cm / 6¾"
Ferozell faces only, pair

Putti



23-3230-30 30 cm / 12"

Putti



23-3235-27 27 cm / 10½"



Fomon



23-3240-21 21 cm / 8¼"

Double ended,
fine and coarse
teeth 4-side,
convex and
flat blades
8 mm width



Murphy-Lane



23-3245-30 30 cm / 12"
Bone skid

Trochlear



Maltz Improved

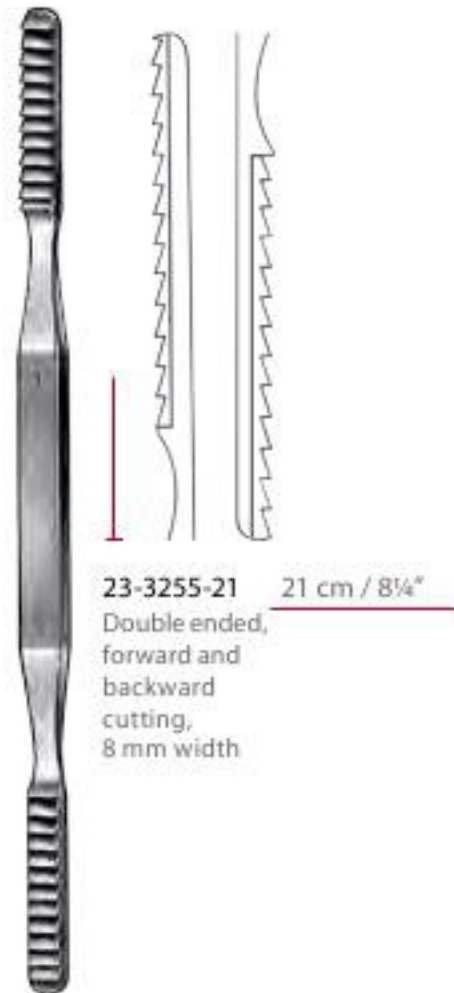

Aufricht

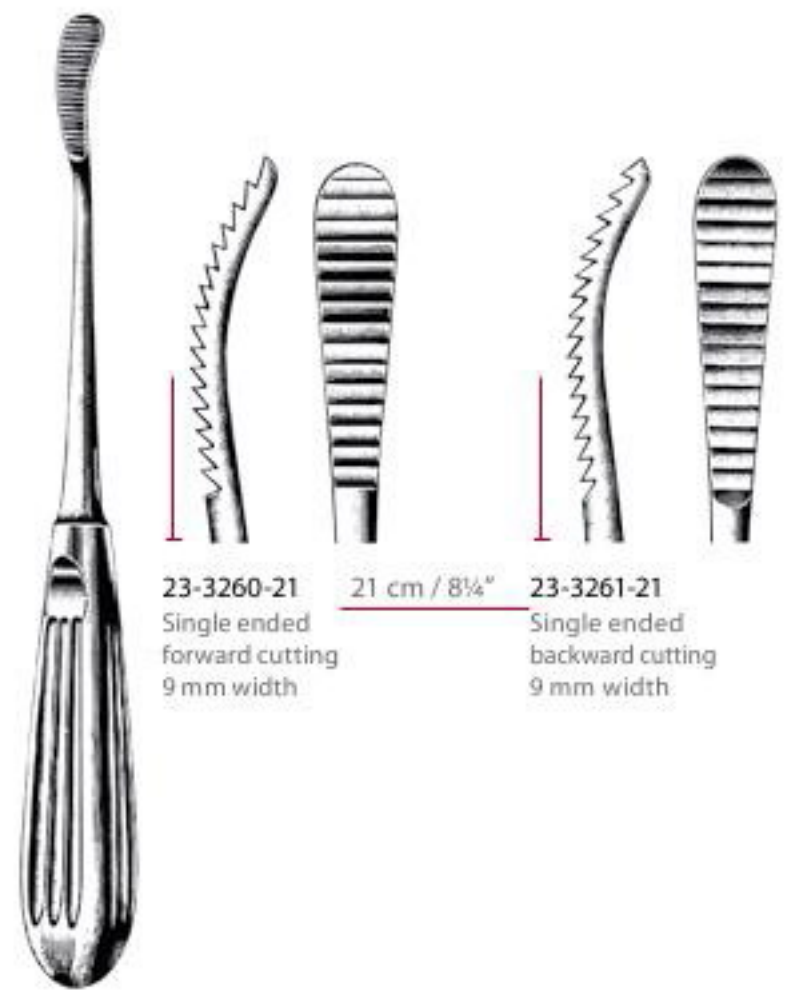

Maltz

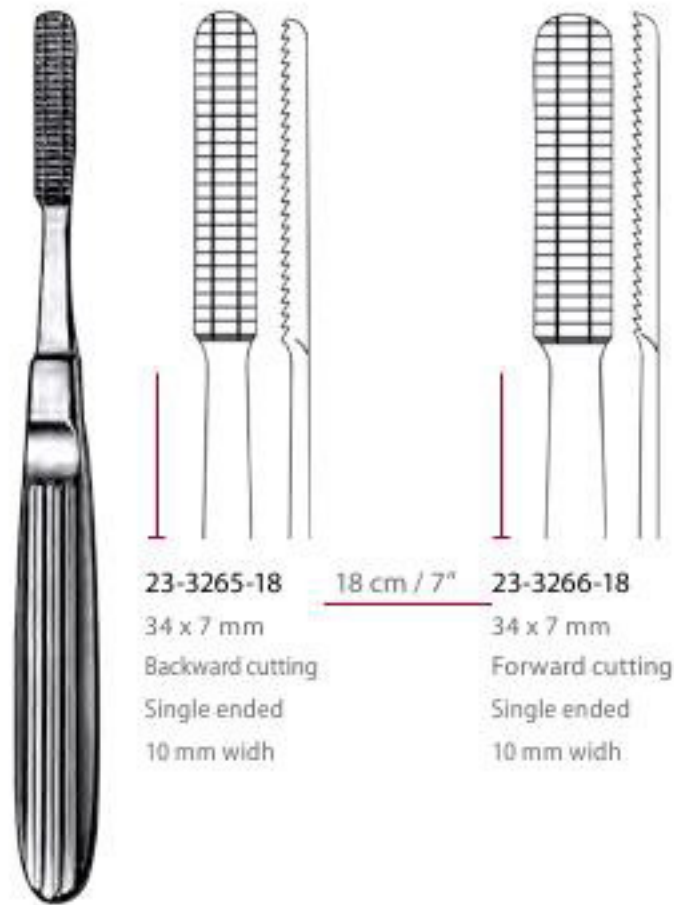

Excision Arthroplasty

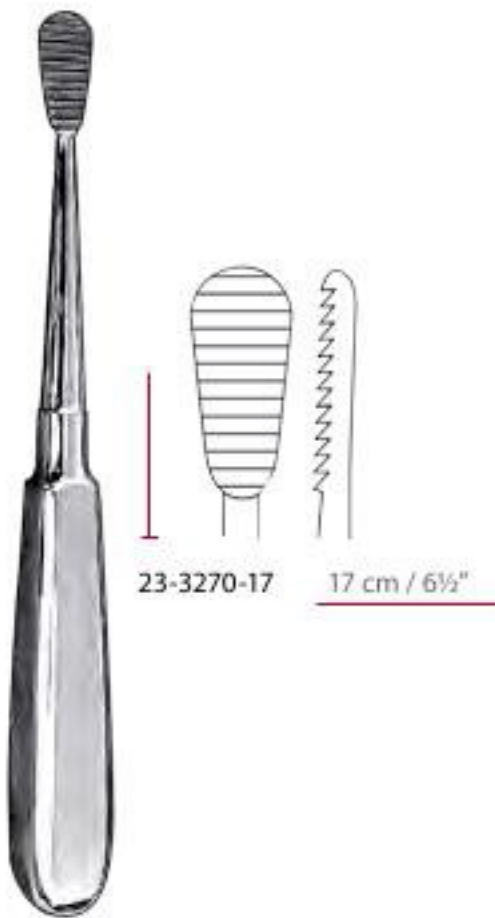

Joseph



Lewis Rasp

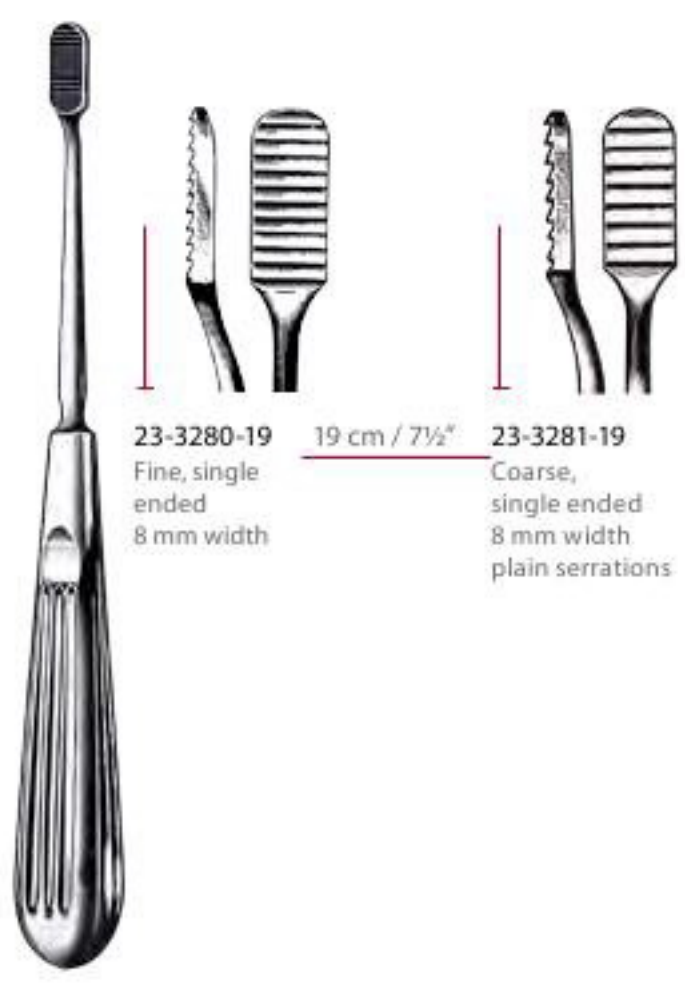

23-3280-19
Fine, single
ended
8 mm width

19 cm / 7½"

23-3281-19
Coarse,
single ended
8 mm width
plain serrations

Cottle Rasp



23-3285-20
Single ended
backward
cutting
9 mm width
plain serrations

20.5 cm / 8"

Miller-Colburn

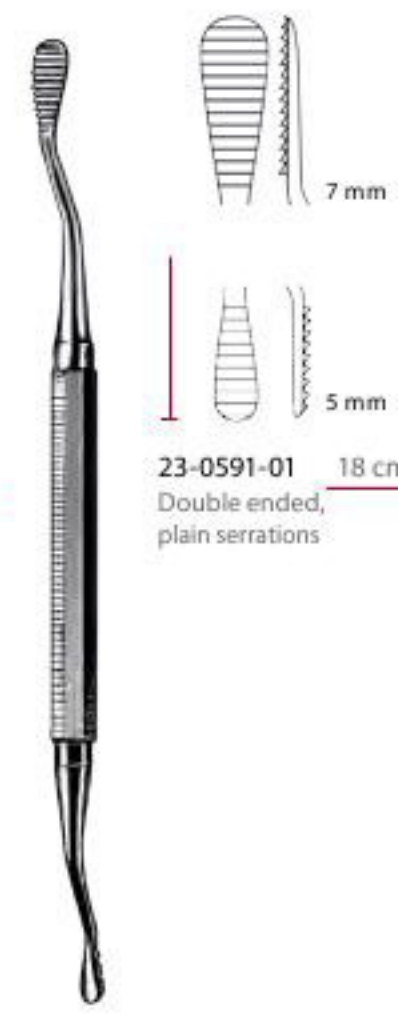

23-0591-01
Double ended,
plain serrations

18 cm / 7"

Miller-Colburn

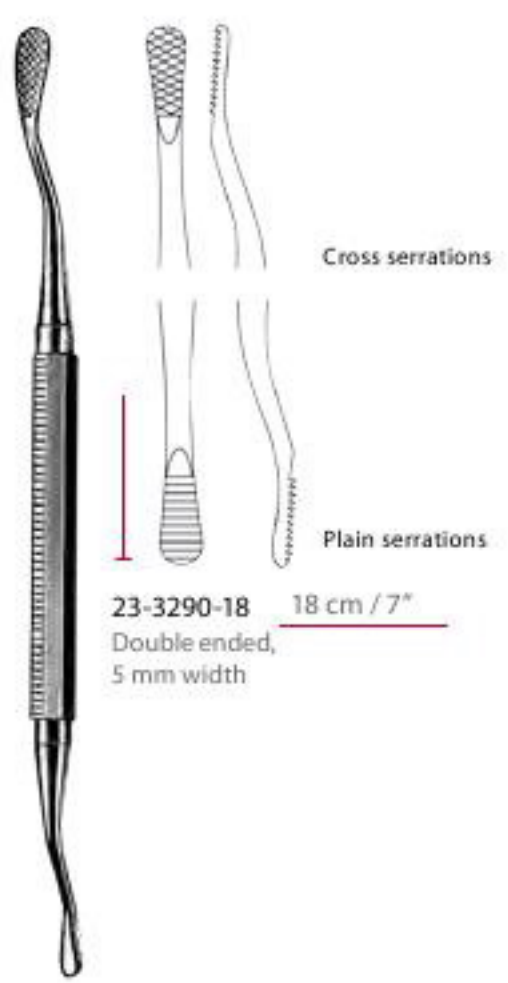

23-3290-18
Double ended,
5 mm width

18 cm / 7"

Miller-Colburn



23-3295-18
Double ended,
cross serrations

18 cm / 7"

Miller-Colburn

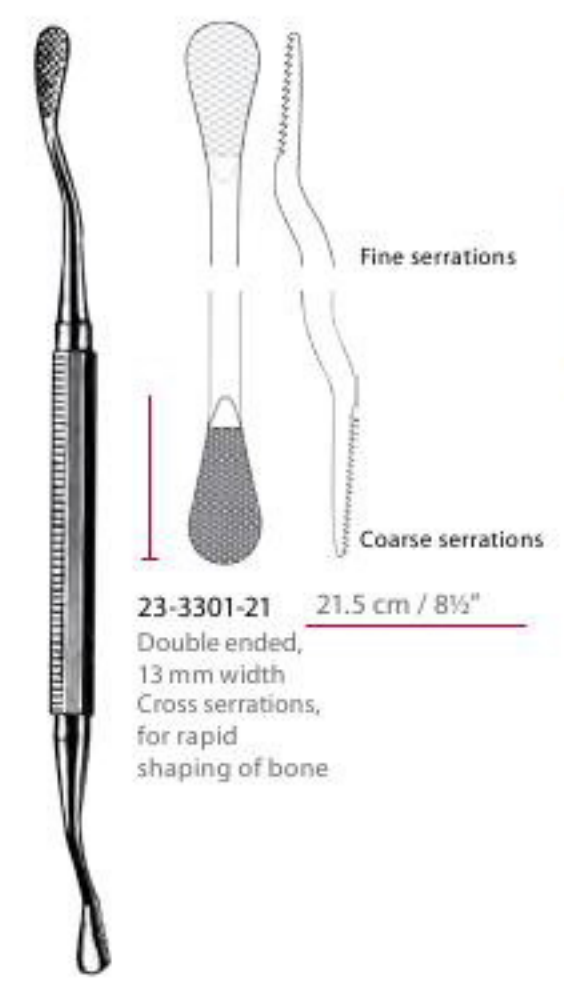

23-3301-21
Double ended,
13 mm width
Cross serrations,
for rapid
shaping of bone

21.5 cm / 8½"

Miller-Colburn



Miller-Colburn



Miller-Colburn



Polokoff Rasp

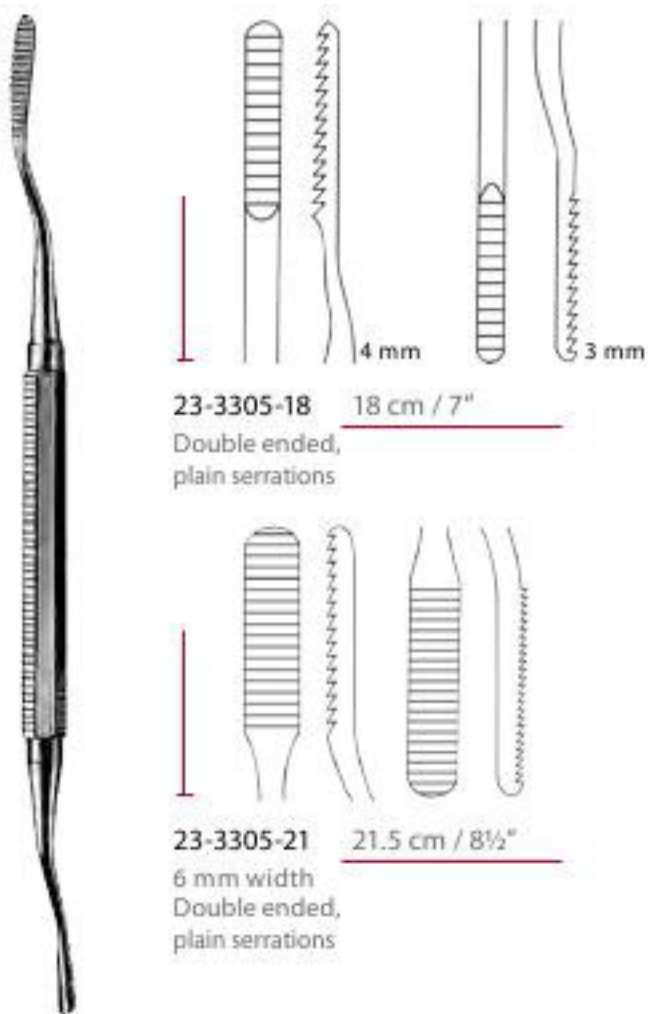

Miller-Colburn



Gigli



23-3355-00
Handle

Olivecrona

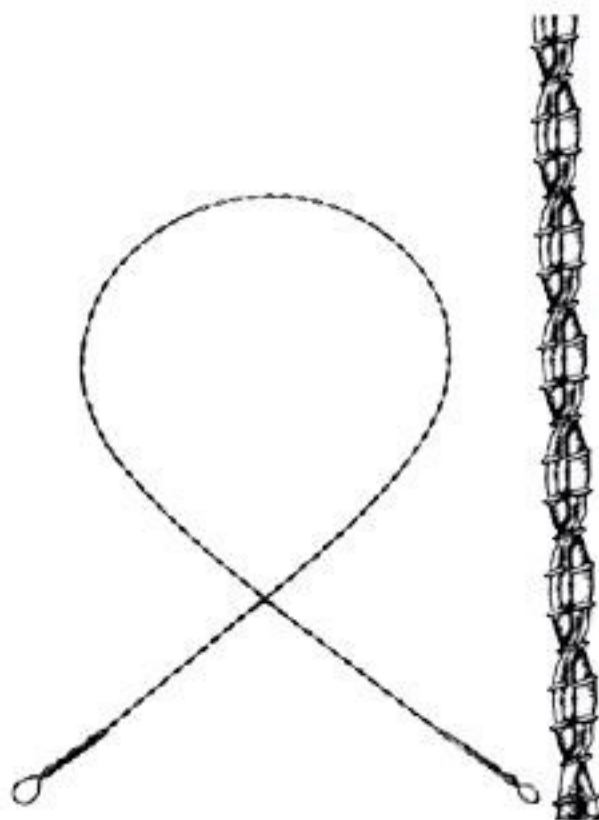

23-3345-30 30 cm / 12"
 23-3345-40 40 cm / 16"
 23-3345-50 50 cm / 20"
 23-3345-70 70 cm / 28"



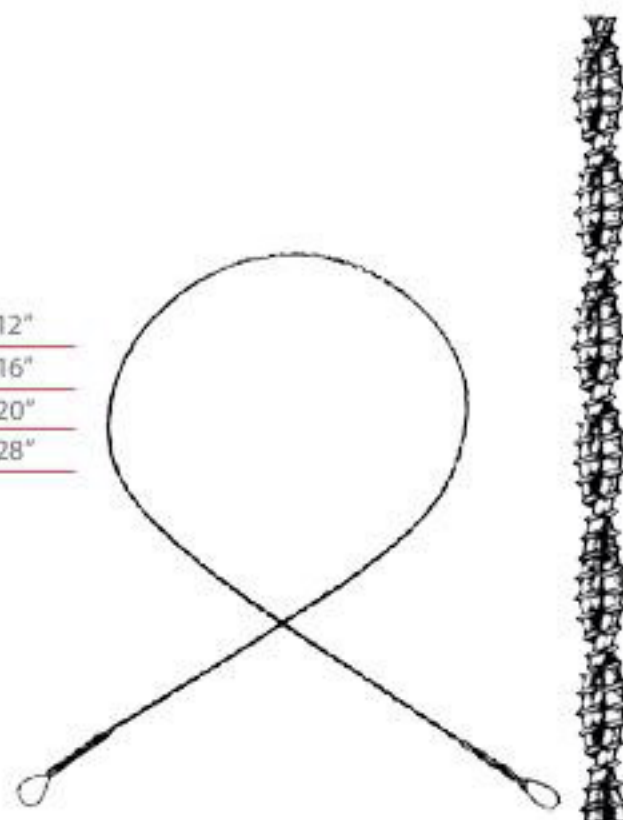







Gigli



23-3350-30 30 cm / 12"
 23-3350-40 40 cm / 16"
 23-3350-50 50 cm / 20"
 23-3351-50 50 cm / 20"
 Fine, 6 wires twisted











Volkmann



	
23-0405-40 Fig. 0000	23-0405-30 Fig. 000
17 cm / 6 3/4"	
	
23-0405-20 Fig. 00	23-0405-10 Fig. 0
17 cm / 6 3/4"	
	
23-0405-01 Fig. 1	23-0405-02 Fig. 2
17 cm / 6 3/4"	
	
23-0405-03 Fig. 3	23-0405-04 Fig. 4
17 cm / 6 3/4"	
	
23-0405-05 Fig. 5	23-0405-06 Fig. 6
17 cm / 6 3/4"	











Spratt



	
23-3630-40 Fig. 0000	23-3630-30 Fig. 000
17 cm / 6 3/4"	
	
23-3630-20 Fig. 00	23-3630-10 Fig. 0
17 cm / 6 3/4"	
	
23-3630-01 Fig. 1	23-3630-02 Fig. 2
17 cm / 6 3/4"	
	
23-3630-03 Fig. 3	23-3630-04 Fig. 4
17 cm / 6 3/4"	
	
23-3630-05 Fig. 5	23-3630-06 Fig. 6
17 cm / 6 3/4"	

Bruns



				
23-0409-40 Fig. 0000	23-0409-30 Fig. 000	23-0409-20 Fig. 00	23-0409-10 Fig. 0	23-0409-01 Fig. 1
17 cm / 6 3/4"				
				
23-0409-02 Fig. 2	23-0409-03 Fig. 3	23-0409-04 Fig. 4	23-0409-05 Fig. 5	23-0409-06 Fig. 6
17 cm / 6 3/4"				

ORTHOPEDIC. Bone Osteotomes Chisels And Gouges

Leibinger Osteotomes

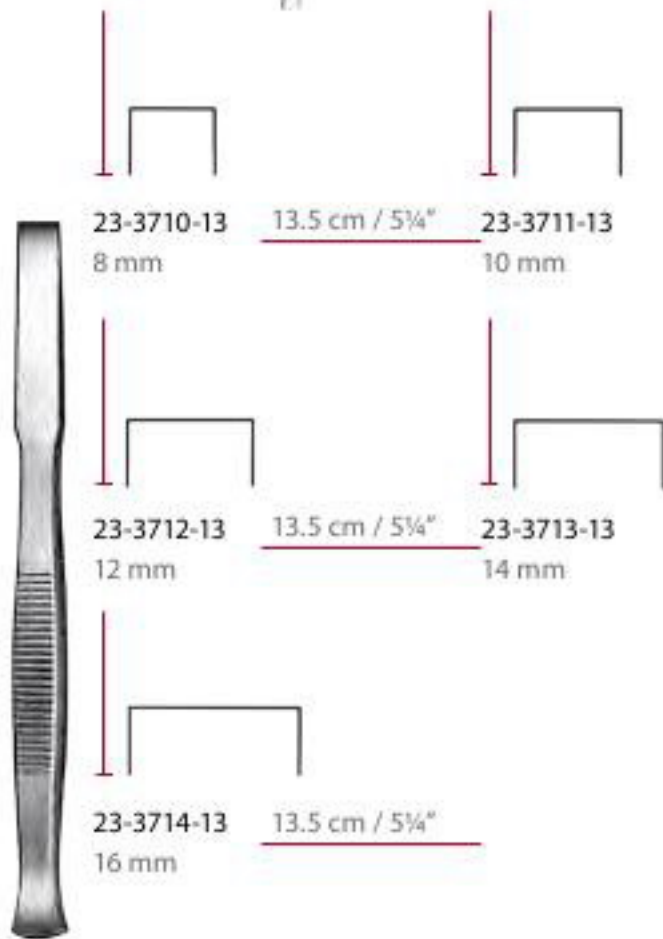

Leibinger Chisels

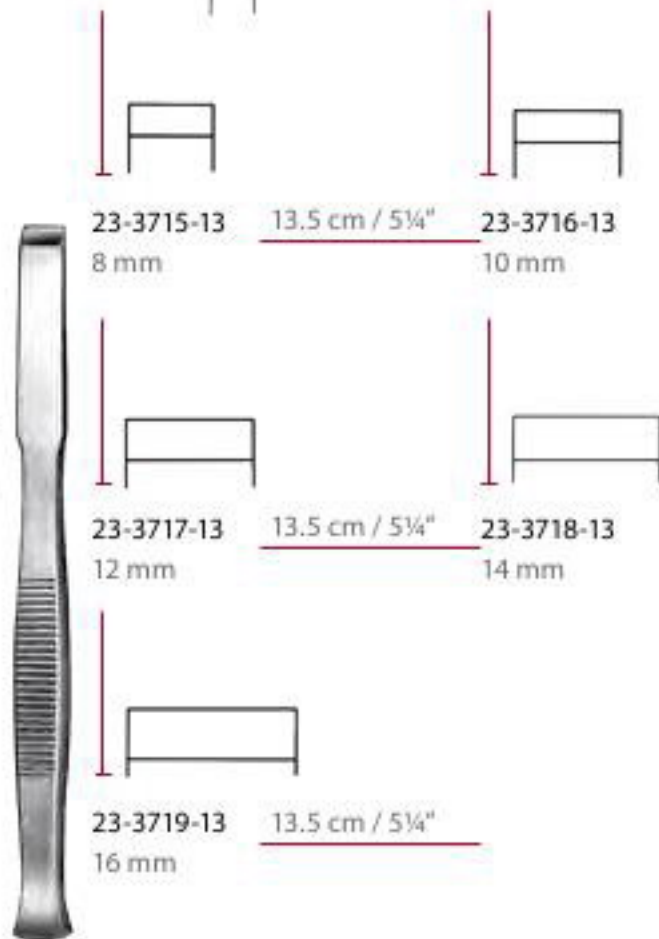

Leibinger Gouges

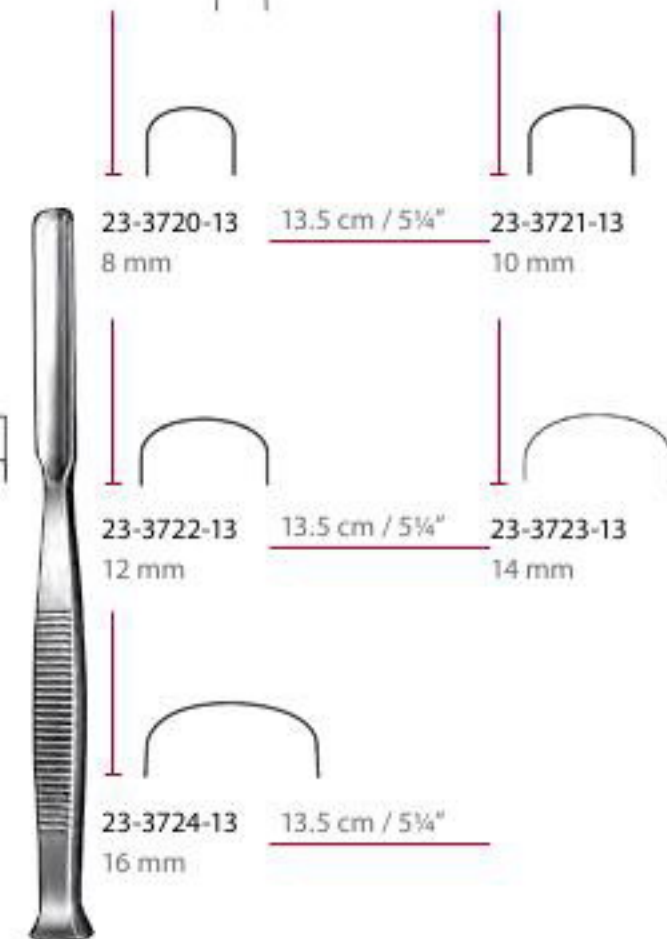

Leibinger Chisels

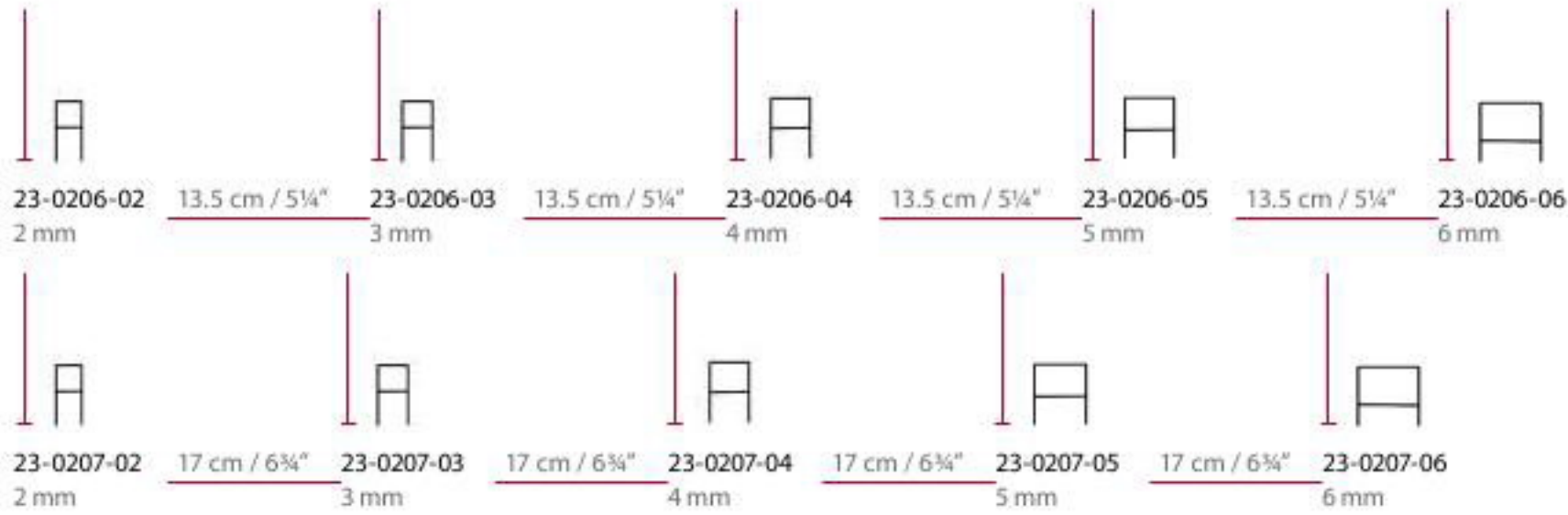

Leibinger Gouges

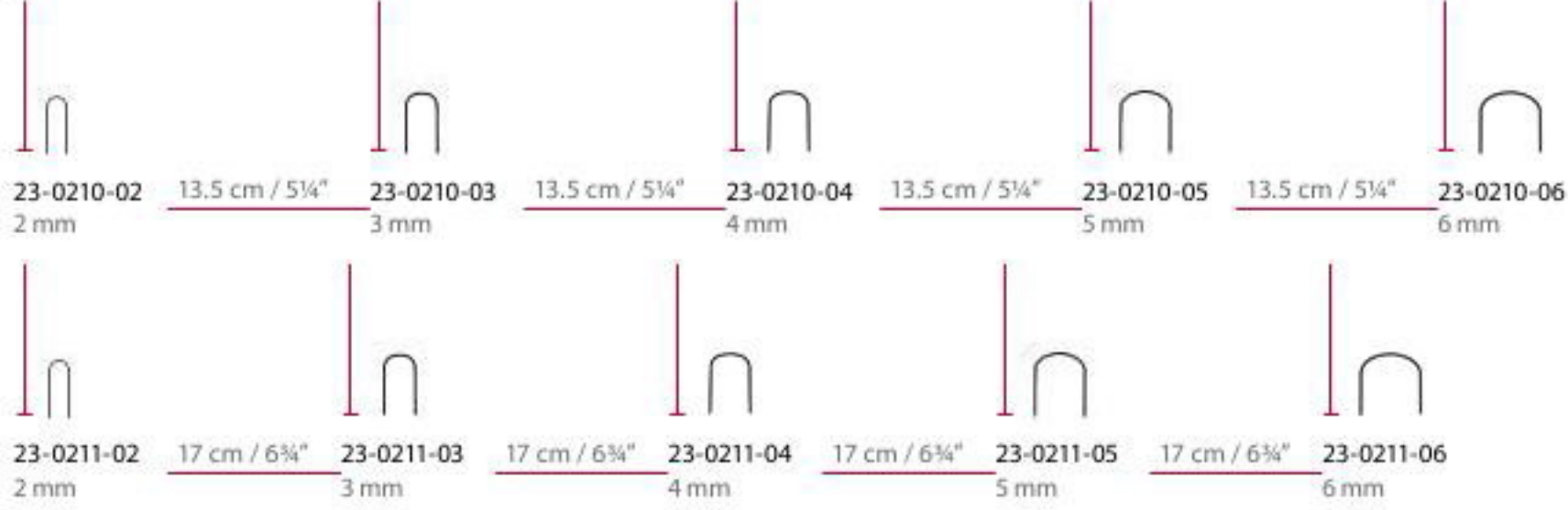

Mini-Lambotte
Osteotome

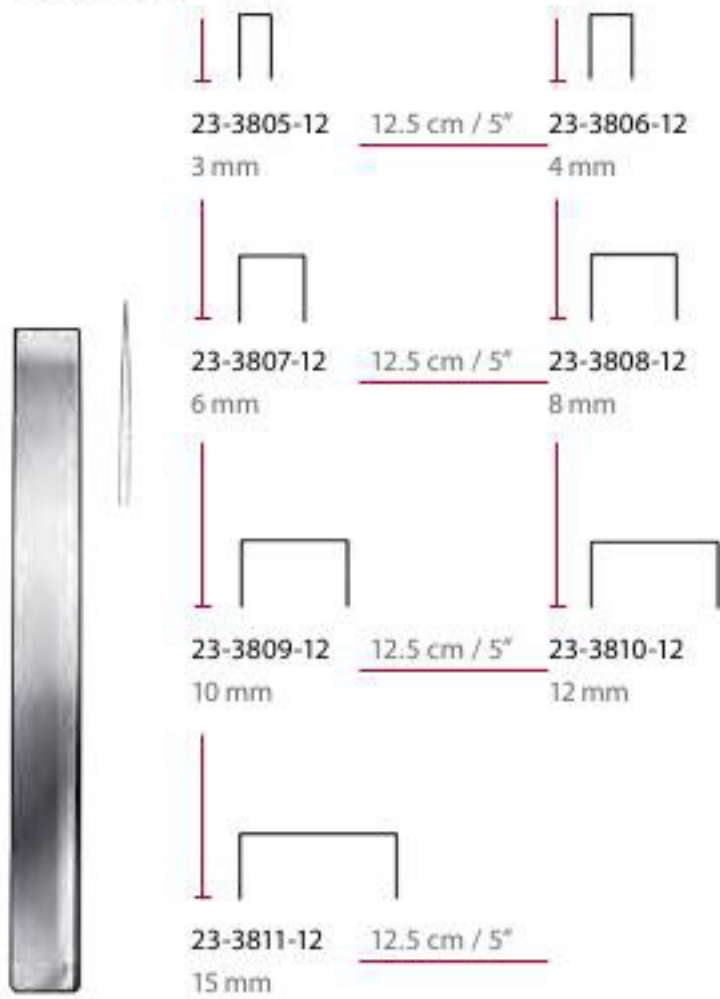

Mini-Lambotte
Osteotome

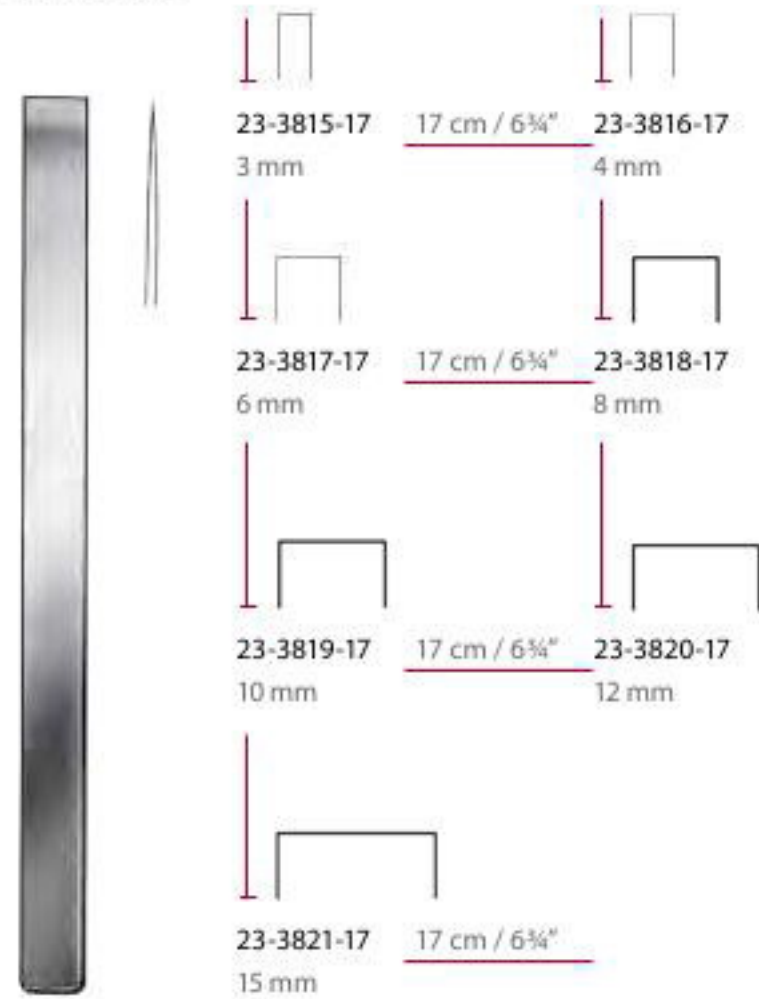

Mini-Lambotte
Osteotome

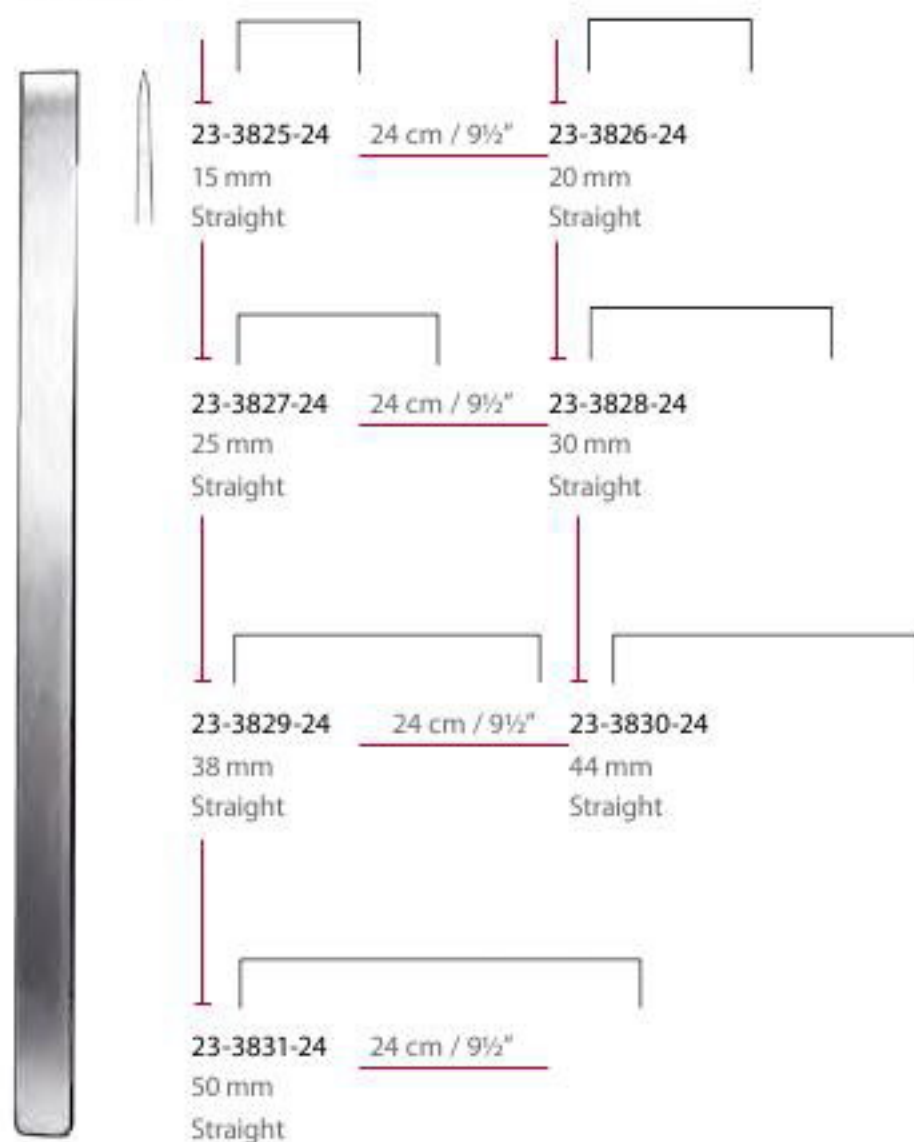

Mini-Lambotte
Osteotome

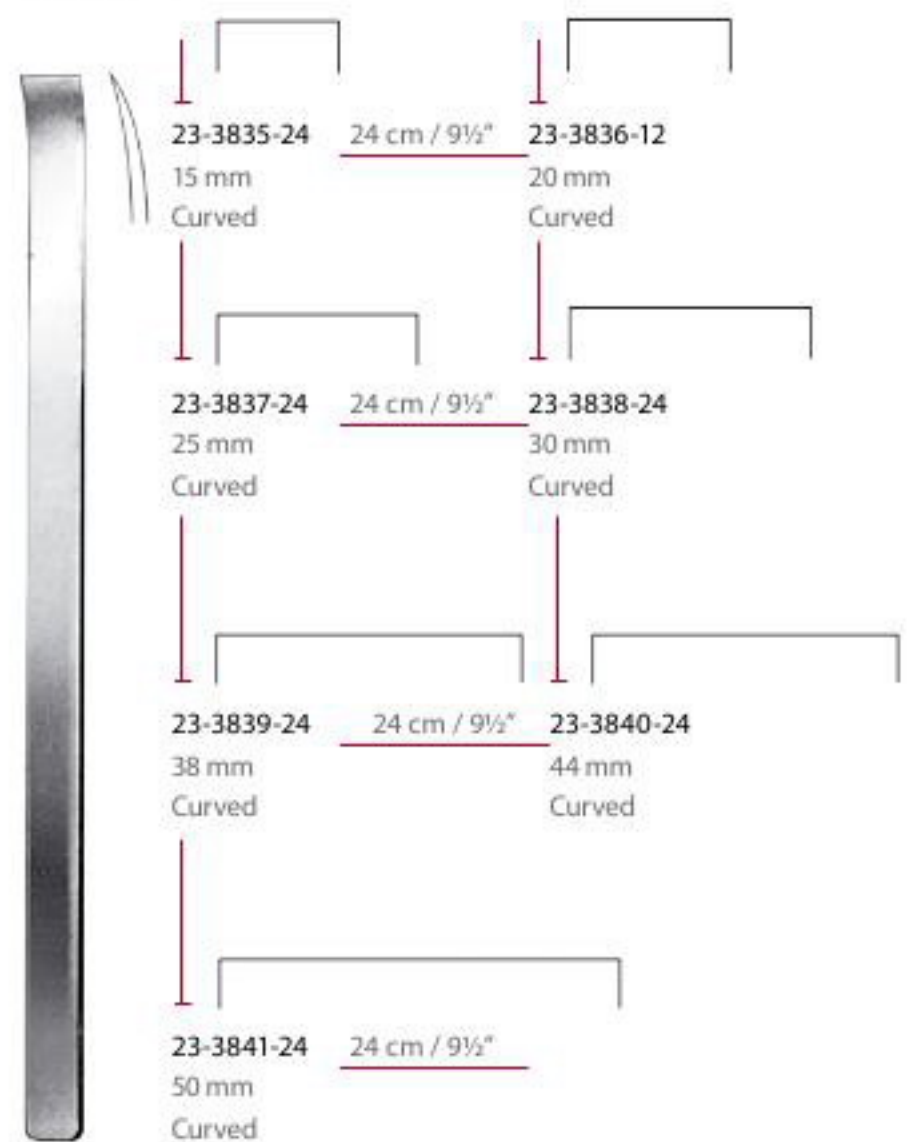

Williger

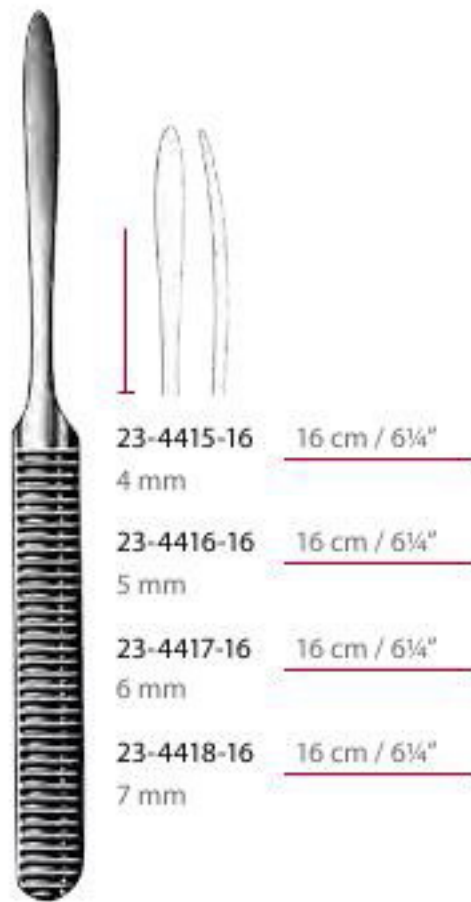

Langenbeck

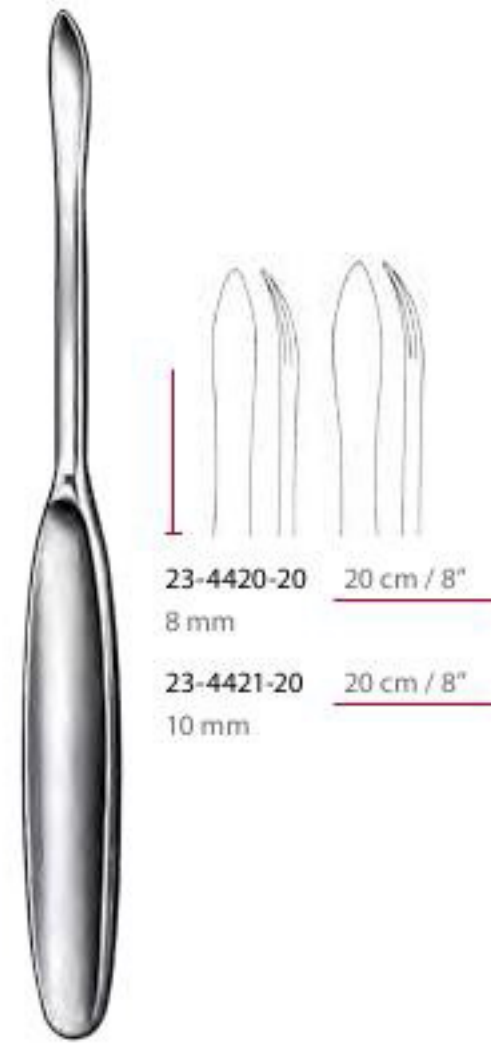

Lambotte

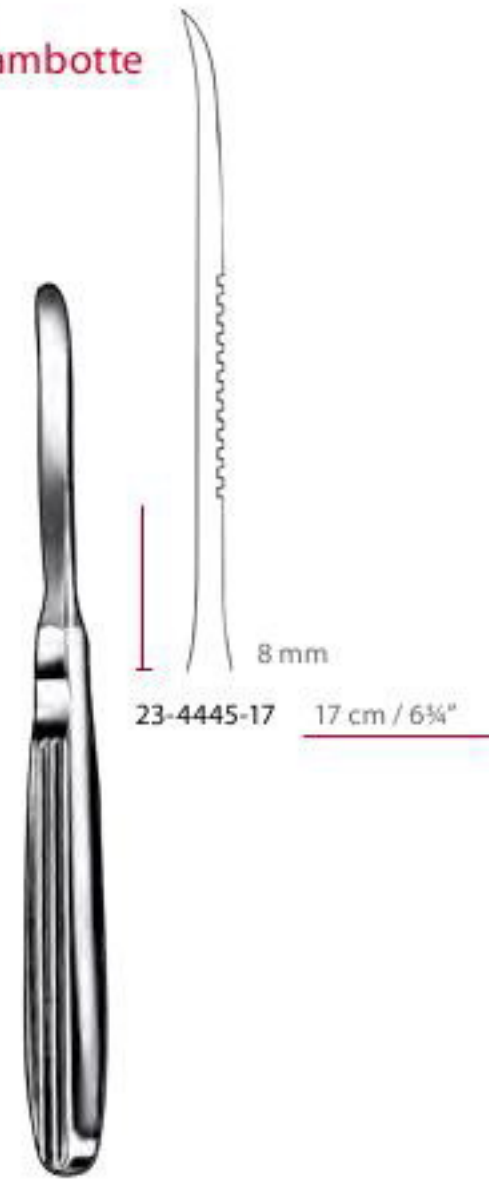

Langenbeck

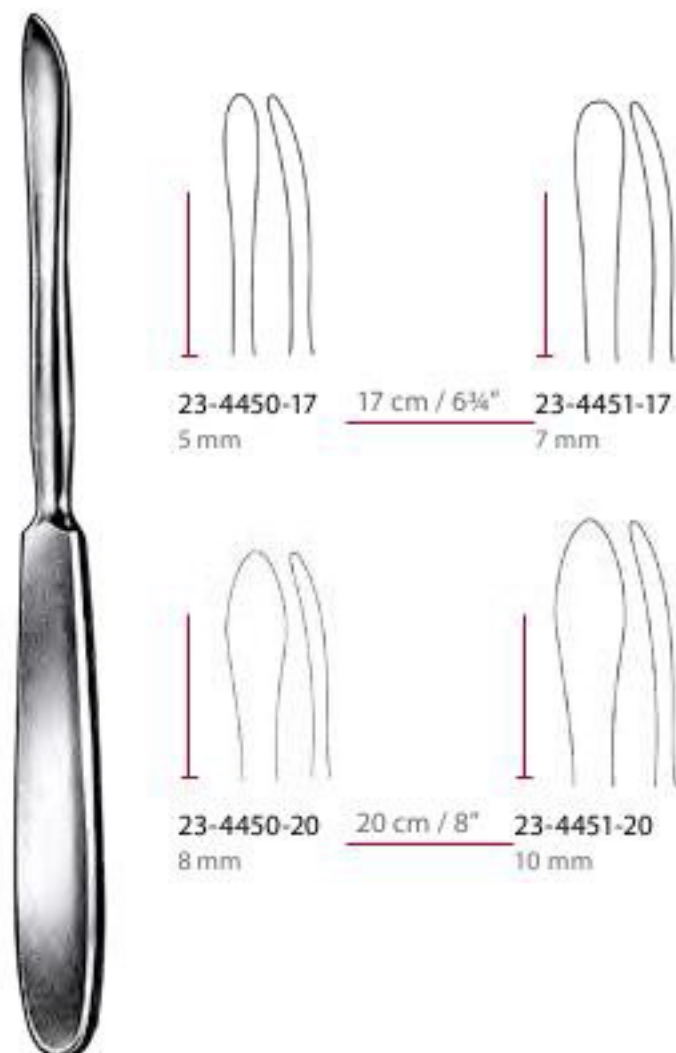

Adson

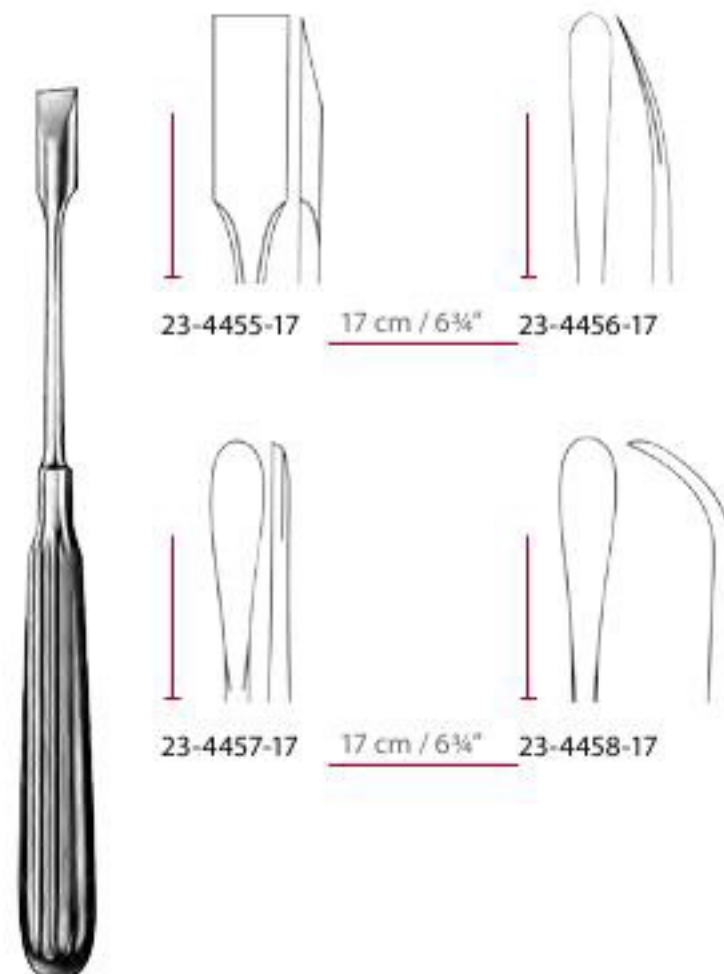

ORTHOPEDIC. Periosteal Elevators

Periosteal Elevator
Ferozell handle



Periosteal Elevator
Ferozell handle



Periosteal Elevator
Ferozell handle



Periosteal Elevator
Ferozell handle



Periosteal Elevator
Ferozell handle



Periosteal Elevator
Ferozell handle



Bone Lever



Bone Lever

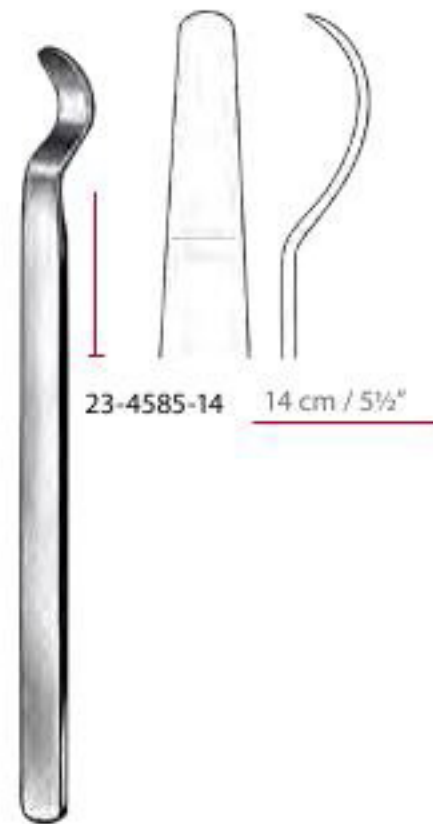

Bone Lever



Bone Lever

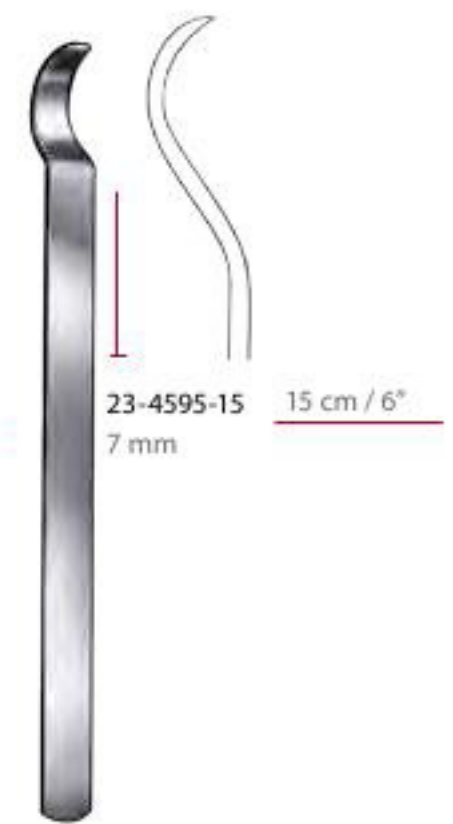

Buck-Gramcko

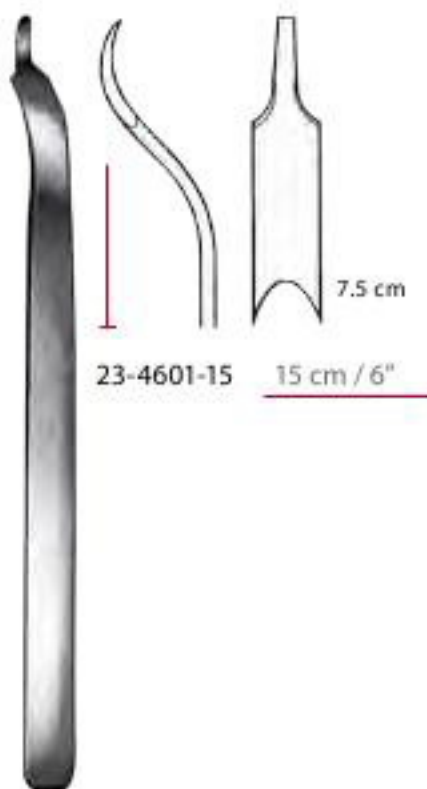

Mini-Hohmann

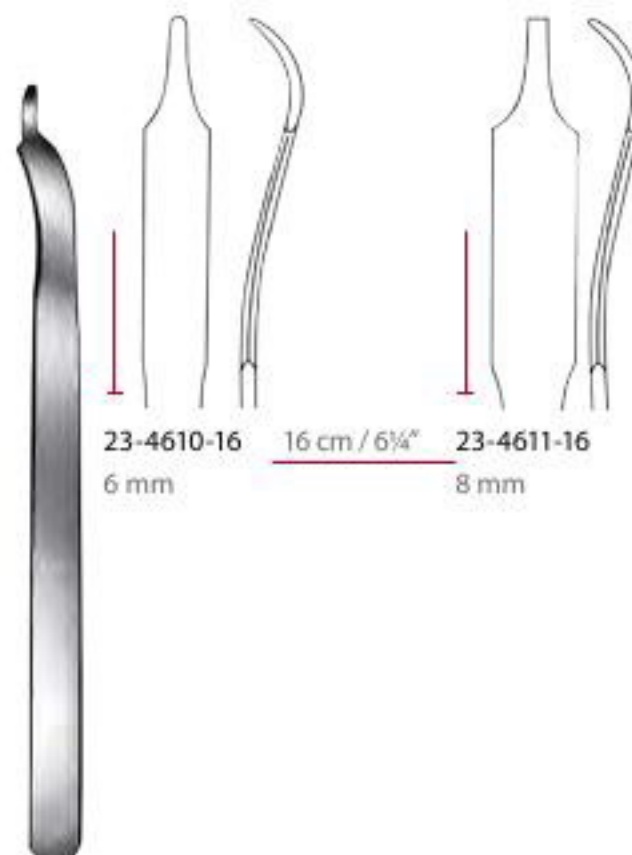

Freer



Hohmann



23-4620-00 22 cm / 8 3/4"
8 mm

Hohmann



23-4625-00 23.5 cm / 9 1/4"
18 mm

Hohmann



23-4630-00 23.5 cm / 9 1/4"
43 mm

Hohmann



23-4635-00 23.5 cm / 9 1/4"
70 mm

Reposition Forceps

Bone Reduction Forceps

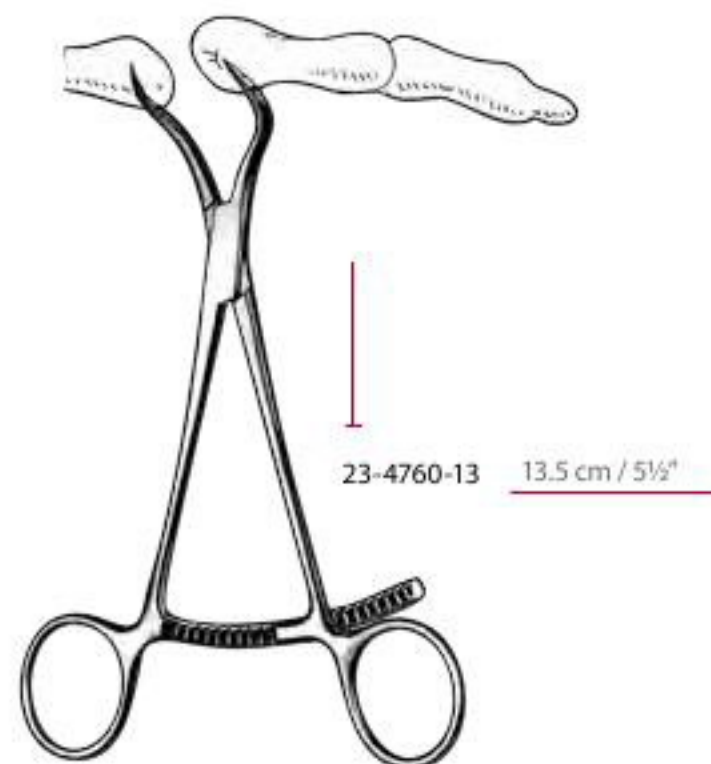

Reposition Forceps

Brand

Bone Reduction Forceps

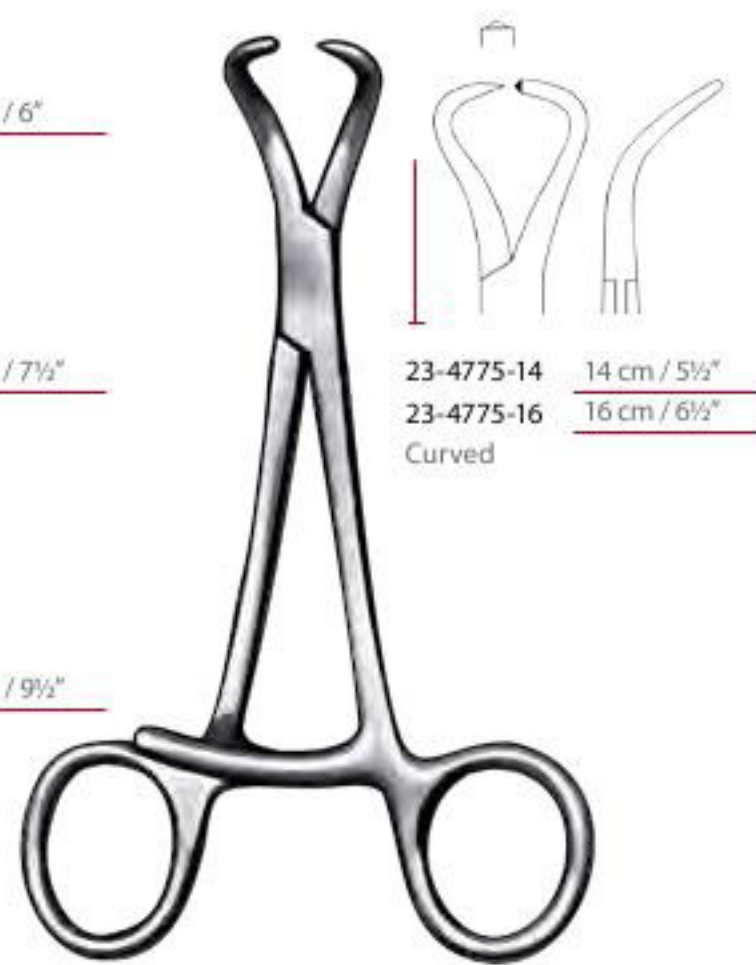
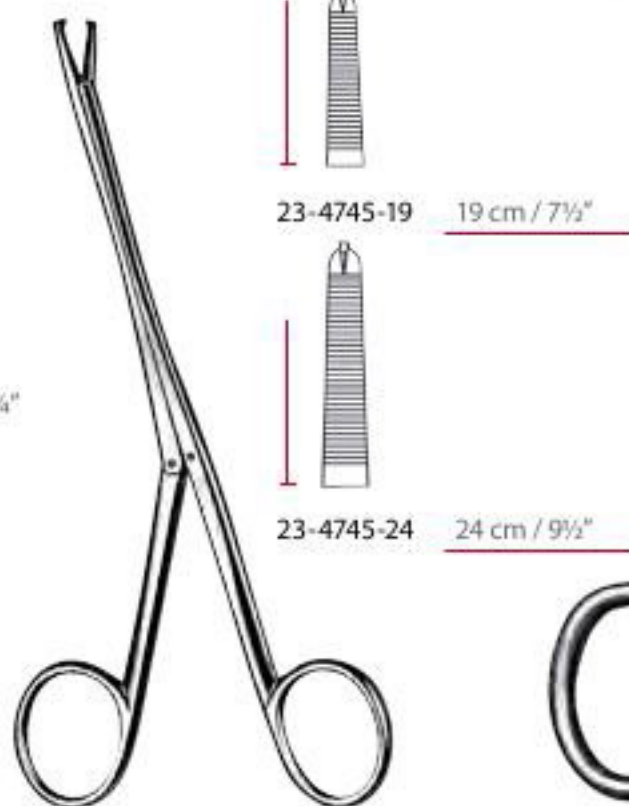
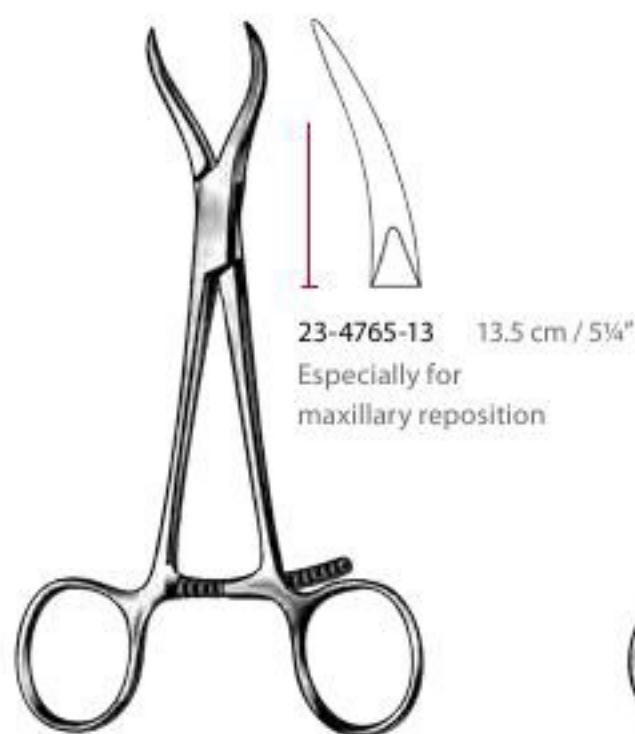

Stagbeetle

Bone Reduction Forceps

Bone Holding Forceps

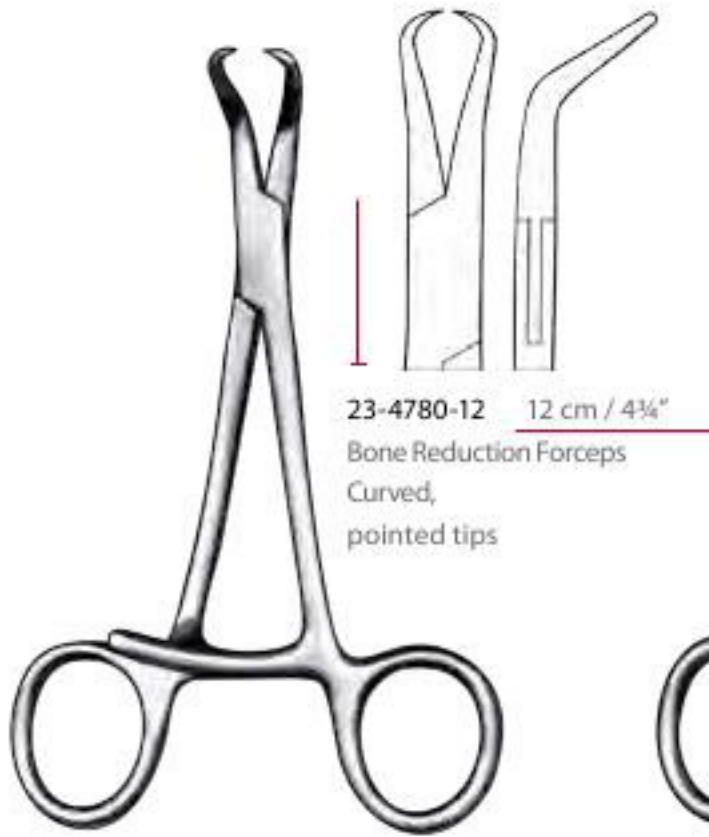

Bone Reduction Forceps

Bone Reduction Forceps

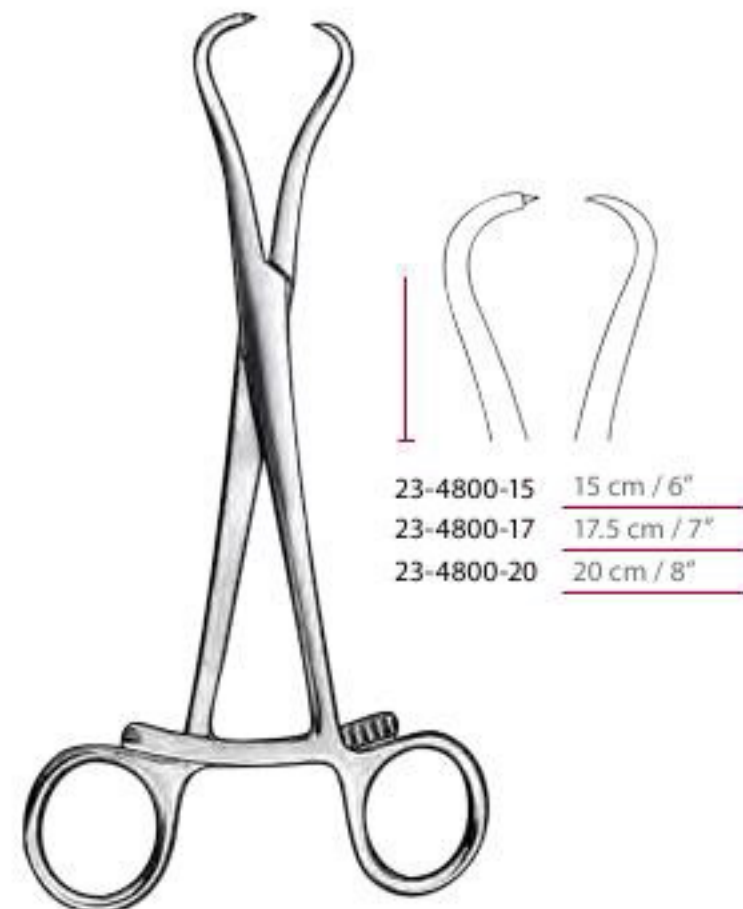
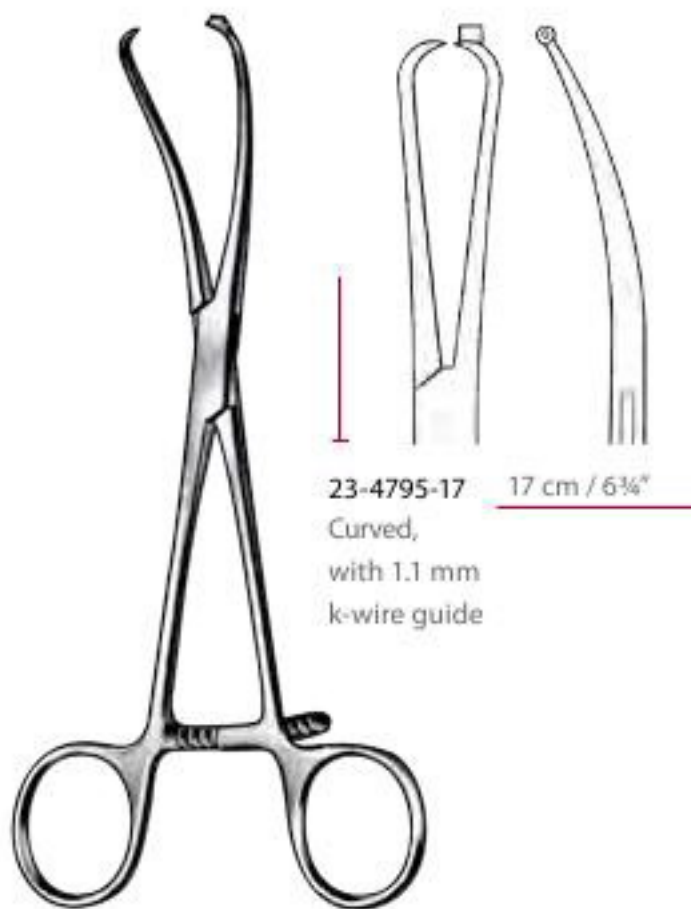

Bone Holding Forceps

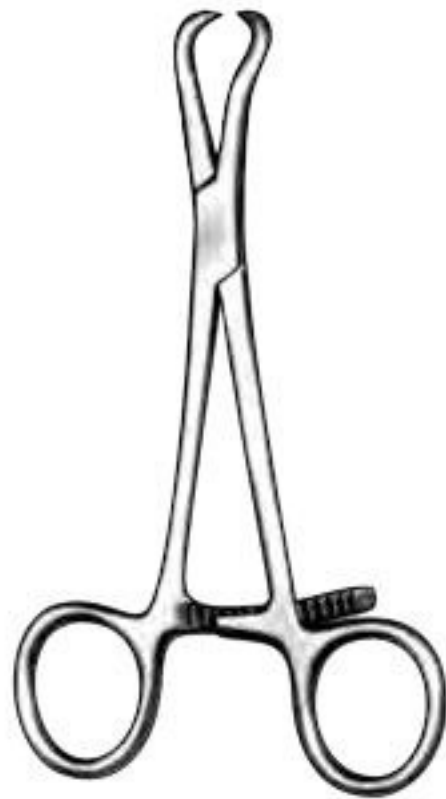

23-4805-12 12.5 cm / 5"
Serrated
10 Teeth

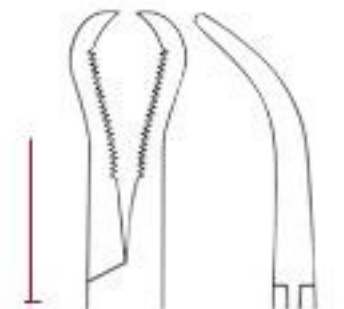

23-4805-14 14 cm / 5½"
Serrated
14 Teeth

Reill



23-4810-17 17.5 cm / 7"
Reposition Forceps
curved,
pointed tips

Steinhauser

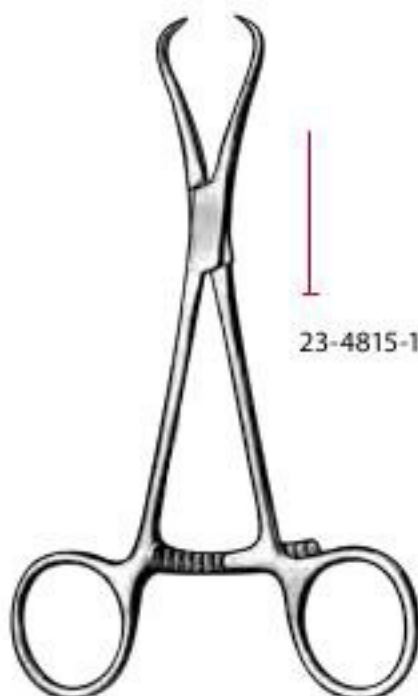

23-4815-13 13 cm / 5"

Steinhauser

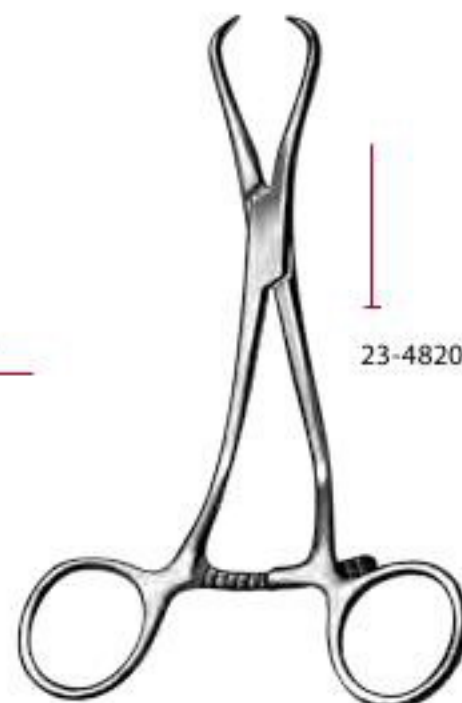

23-4820-13 13 cm / 5"

Bone Fragment Forceps

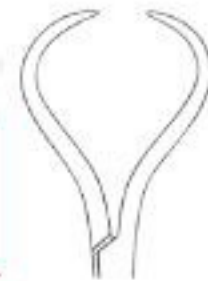

23-4825-16 16 cm / 6¼"

Bone Reduction Forceps

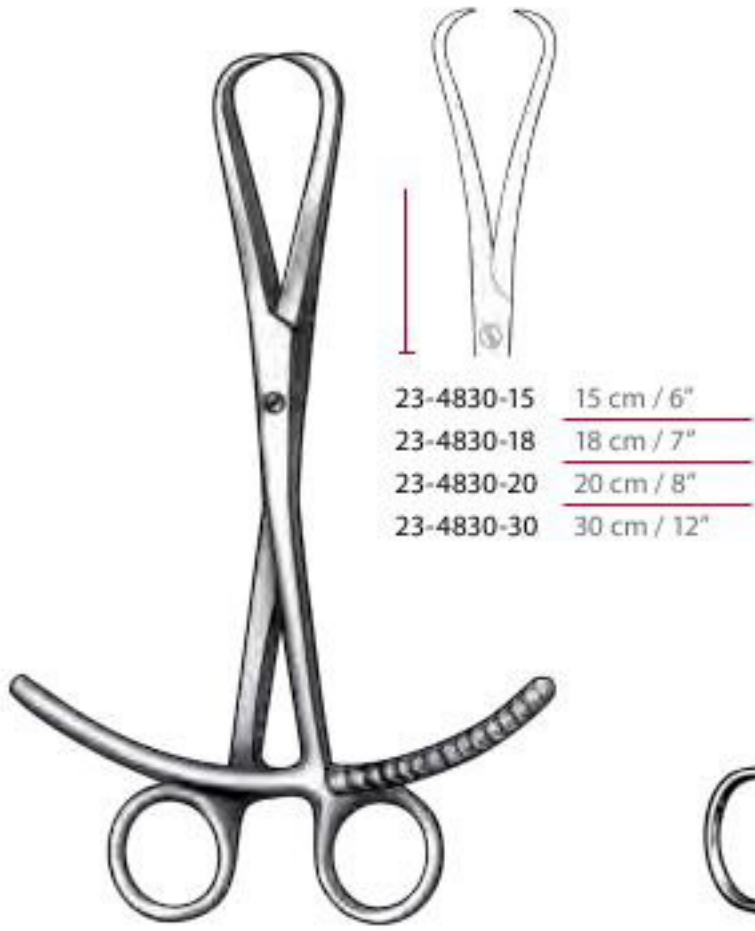

Bone Grasping Forceps

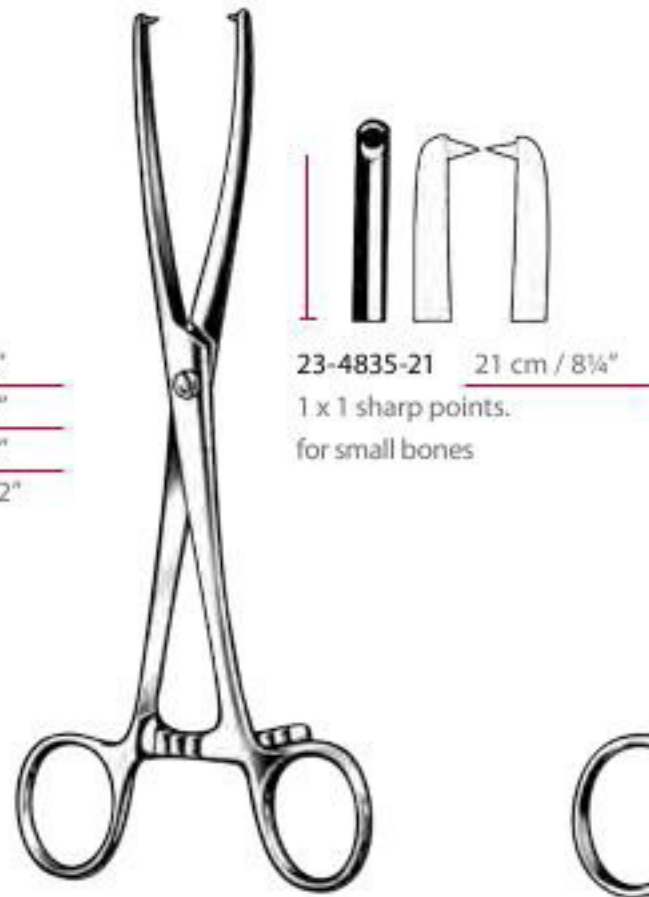

Meyer

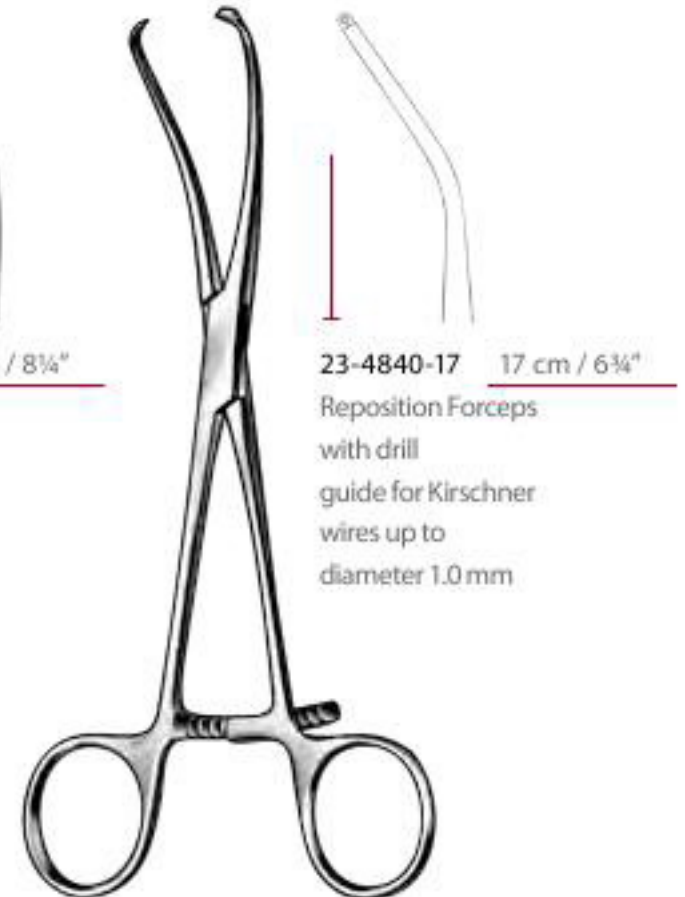

Meyer



Bone Holding Forceps



Locke



Bone Reduction Forceps



23-4860-14 14 cm / 5 1/4"
 for small bones
 curved,
 ratchet length 1 1/4"

Bone Grasping Forceps



23-4870-14 14 cm / 5"
 23-4870-19 19 cm / 7 1/2"

Lewin



23-4875-17 17.5 cm / 7"

Dingmann



23-4880-18 18.5 cm / 7 1/4"
 Delicate

Dingmann



23-4885-18 18.5 cm / 7 1/4"
 Standard

Verbrugge

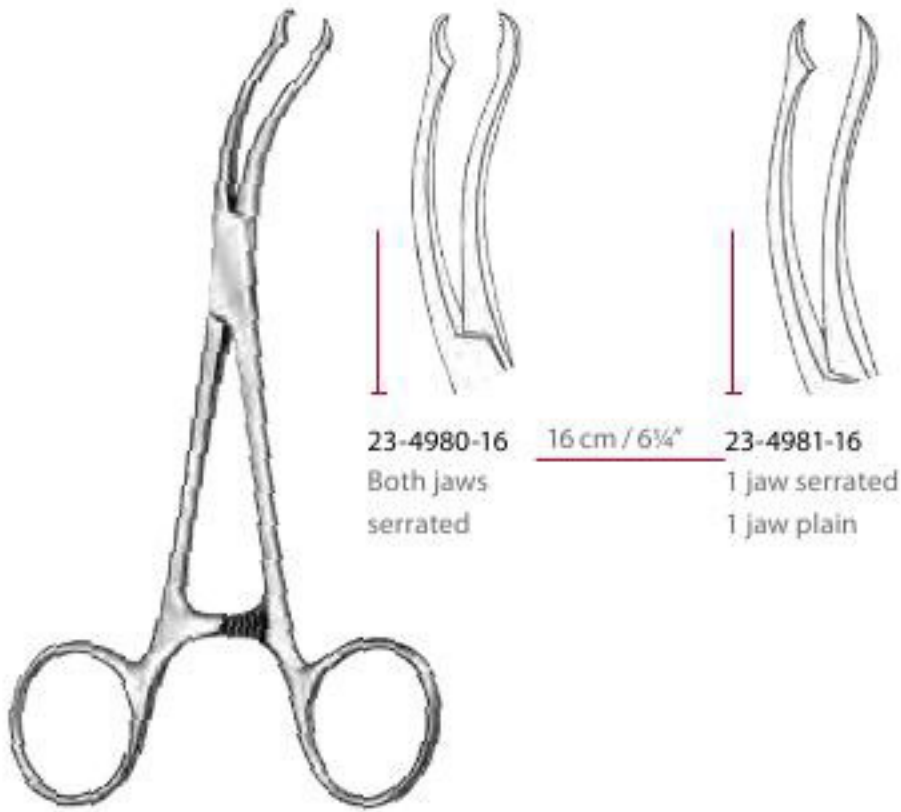

23-4980-16	16 cm / 6¼"	23-4981-16
Both jaws serrated		1 jaw serrated 1 jaw plain

Verbrugge

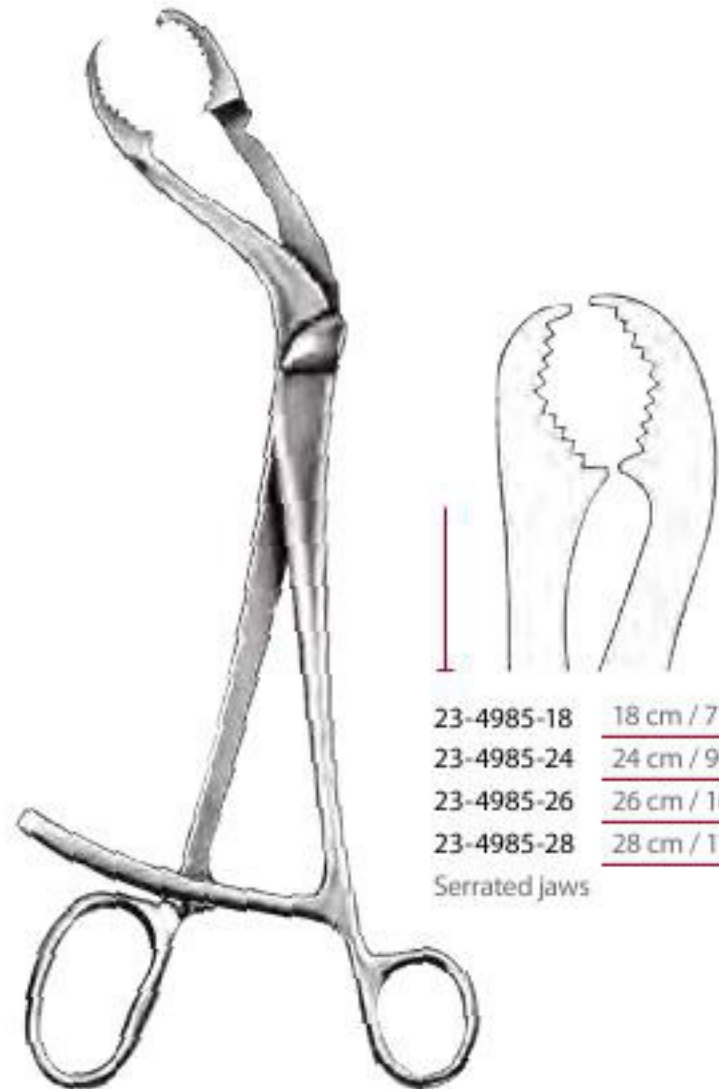

23-4985-18	18 cm / 7"
23-4985-24	24 cm / 9½"
23-4985-26	26 cm / 10¼"
23-4985-28	28 cm / 11"
Serrated jaws	

Kern



23-4945-12	12 cm / 4¾"
23-4945-15	15 cm / 6"
23-4945-17	17 cm / 6¾"
23-4945-21	21 cm / 8¼"
Without ratchet	

Kern

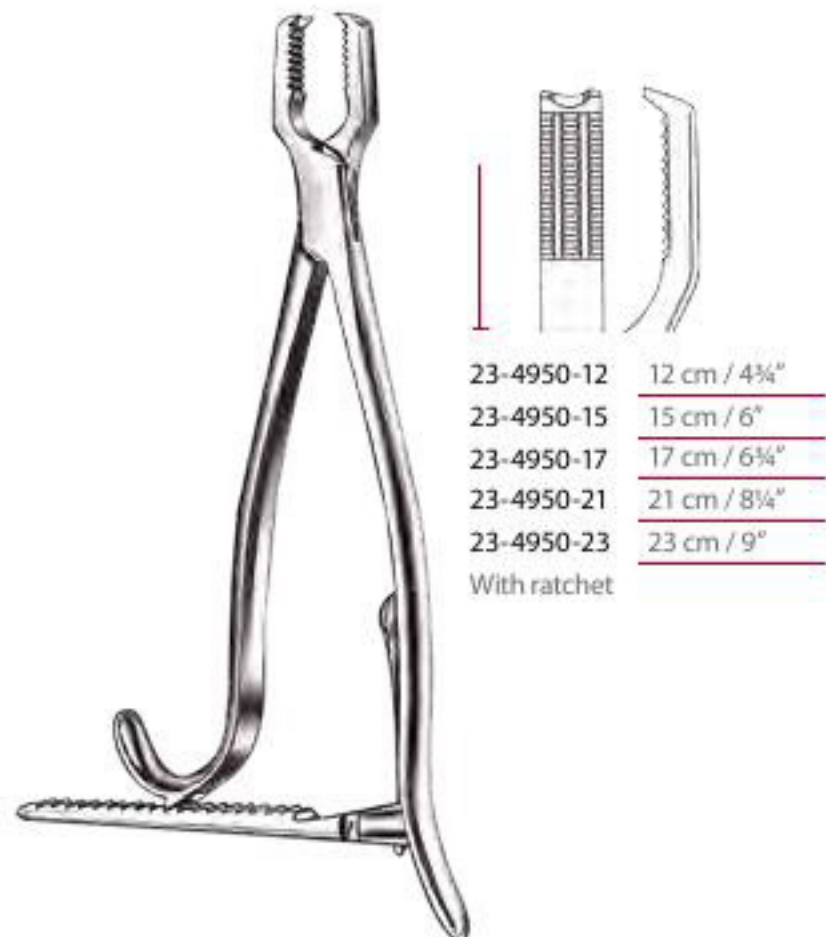

23-4950-12	12 cm / 4¾"
23-4950-15	15 cm / 6"
23-4950-17	17 cm / 6¾"
23-4950-21	21 cm / 8¼"
23-4950-23	23 cm / 9"
With ratchet	

Bone Holding Forceps

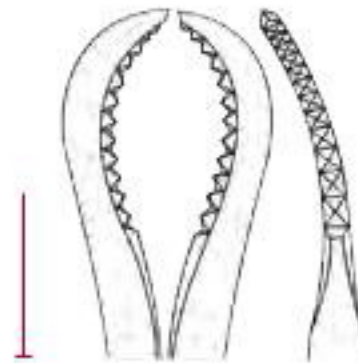

23-5005-16	16 cm / 6¼"
23-5005-18	18 cm / 7"
23-5005-20	20 cm / 8"
23-5005-22	22 cm / 9"
23-5005-24	24 cm / 9½"
23-5005-26	26 cm / 10¼"
23-5005-28	28 cm / 11"

Patella Forceps



23-5010-18 18 cm / 7"
 2 x 2 sharp teeth
 with speed lock

ORTHOPEDIC. Bone Holding Forceps



23-5025-15 15 cm / 6" Standard jaws
 23-5026-15 15 cm / 6" Reverse jaws
 23-5027-15 Moveable jaws



25-5025-19 19 cm / 7½" Standard jaws
 25-5026-19 19 cm / 7½" Reverse jaws
 25-5027-19 Moveable jaws



23-5025-24 24 cm / 9½" Standard jaws
 23-5026-24 24 cm / 9½" Reverse jaws
 23-5027-24 Moveable jaws

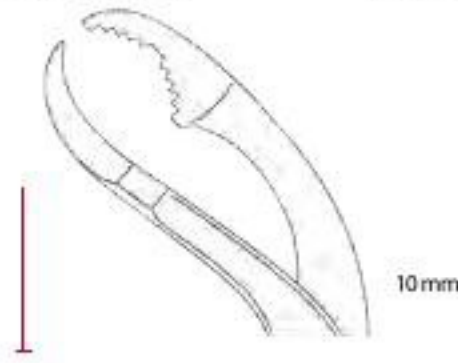

23-5025-26 26 cm / 10¼" Standard jaws
 23-5026-26 26 cm / 10¼" Reverse jaws
 23-5027-26 Moveable jaws



23-5025-22 22 cm / 8½" Standard jaws
 23-5026-22 22 cm / 8½" Reverse jaws
 23-5027-22 Moveable jaws

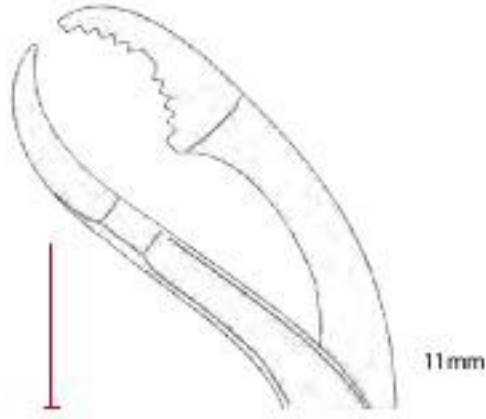

23-5025-28 28 cm / 11" Standard jaws
 23-5026-28 28 cm / 11" Reverse jaws
 23-5027-28 Moveable jaws

Self-Centering Forceps



Standard jaws

Self-Centering Forceps



With thread fixation
 Reverse jaws

Verbrugge

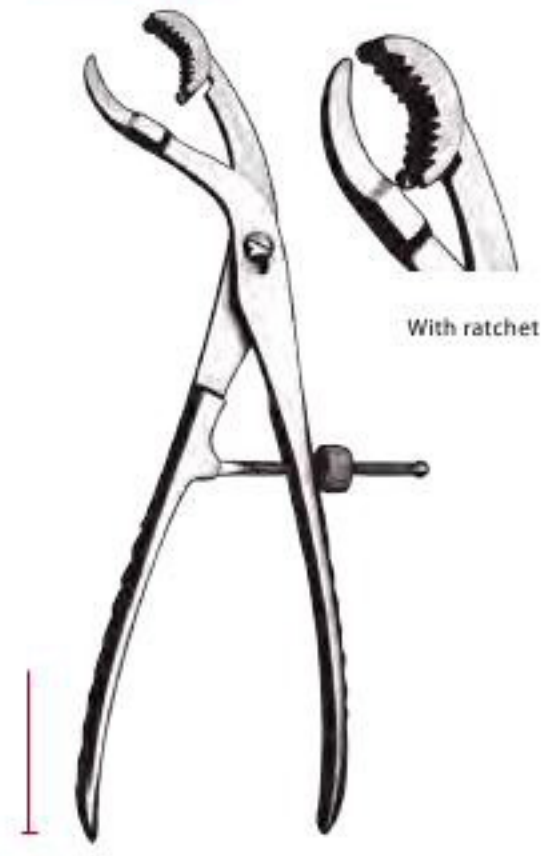

28 cm / 11"
 With moveable jaws

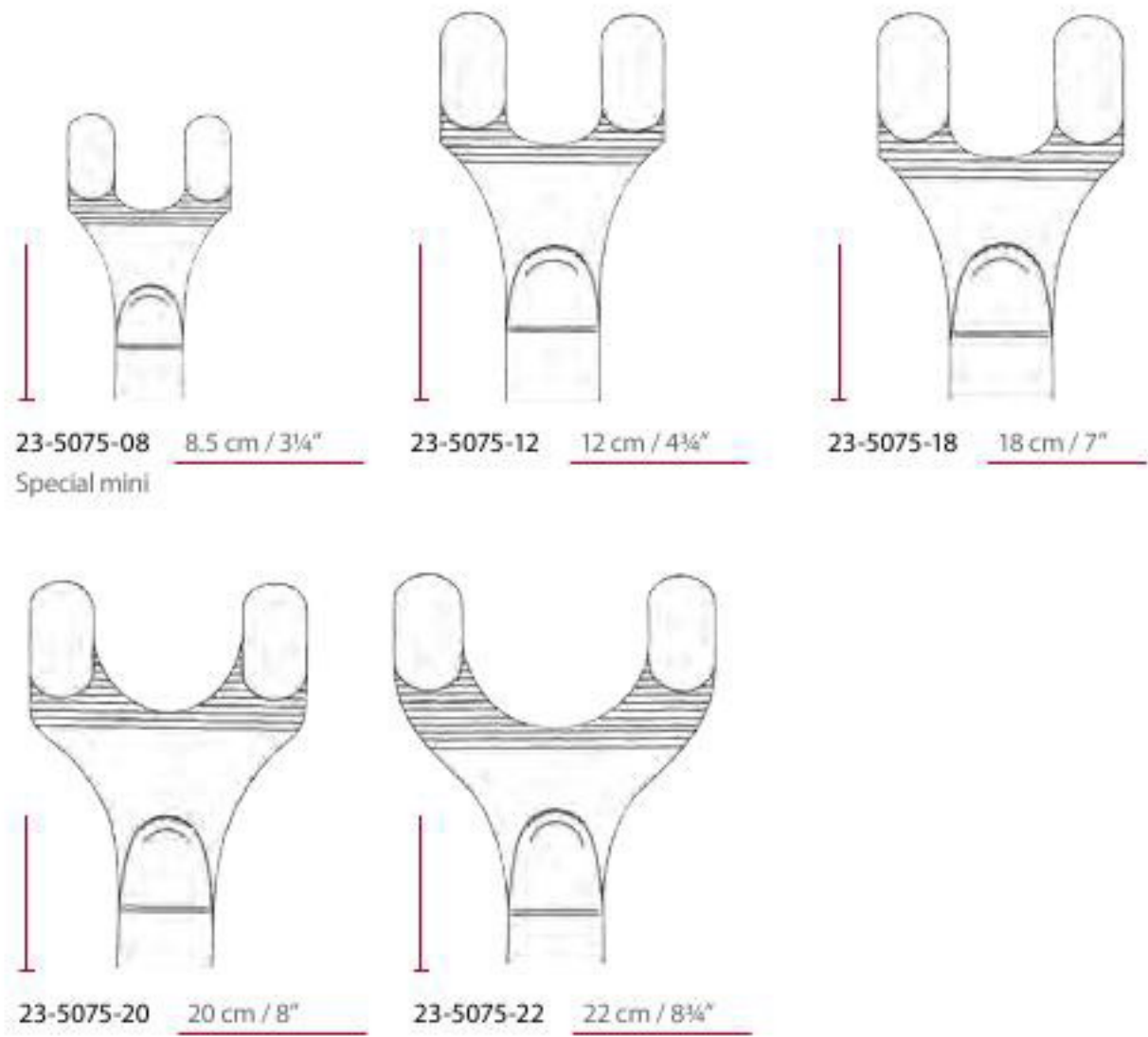
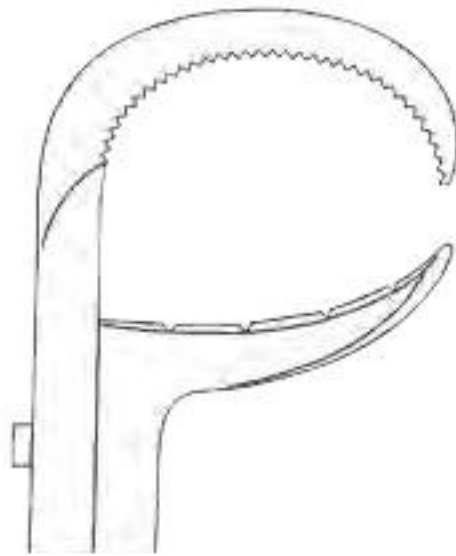

Gerster - Lowmann
1 x 2 jaws



Gerster
Traction Bar

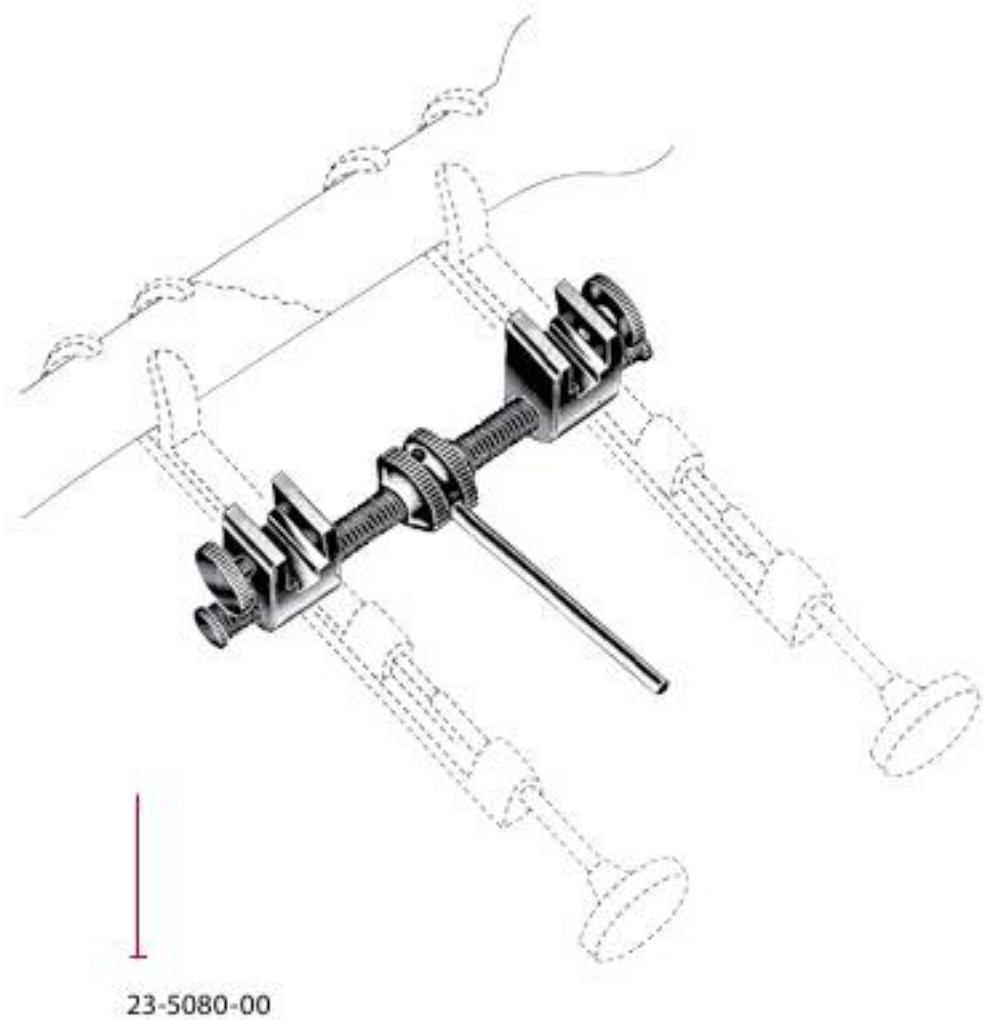

Lowmann
1 x 1 jaws

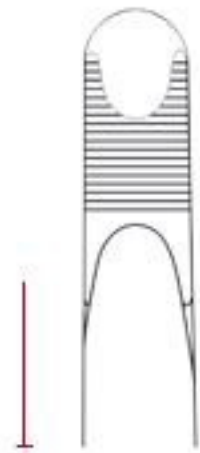

23-5085-12	12 cm / 4¾"
23-5085-18	18 cm / 7¼"
23-5085-20	20 cm / 8"

Bone clamp

Lowmann
2 x 2 jaws

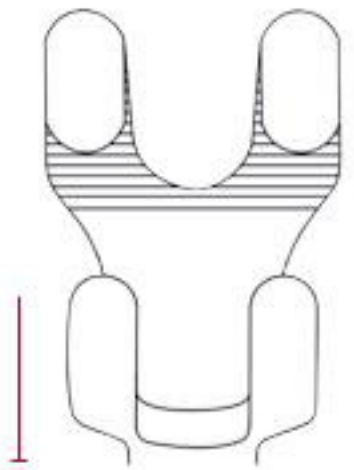

23-5090-18	18.5 cm / 7¼"
23-5090-20	20 cm / 8"

Bone clamp
Moveable Jaws

Lowman Hoglund

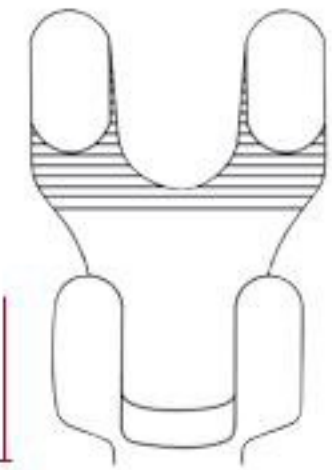

23-5095-12	12 cm / 4¾"
23-5095-18	18 cm / 7¼"
23-5095-20	20 cm / 8"

Mini-Friedmann

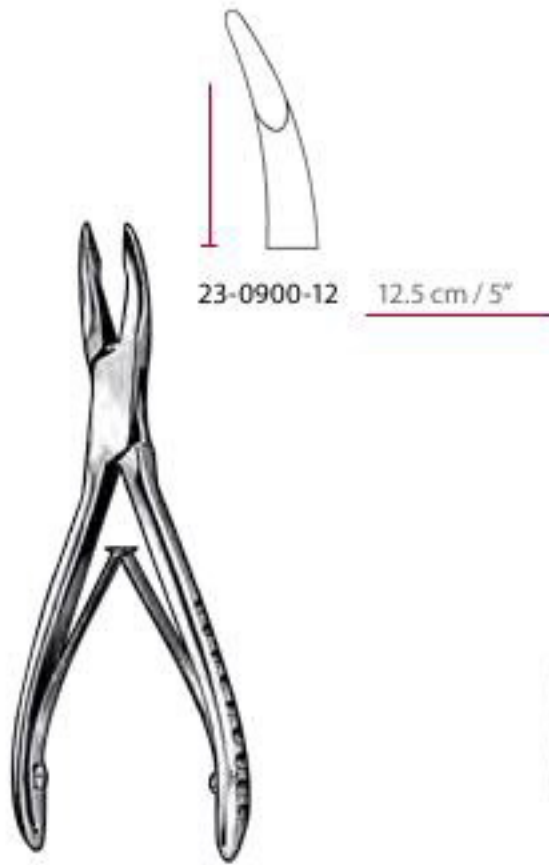

Friedmann

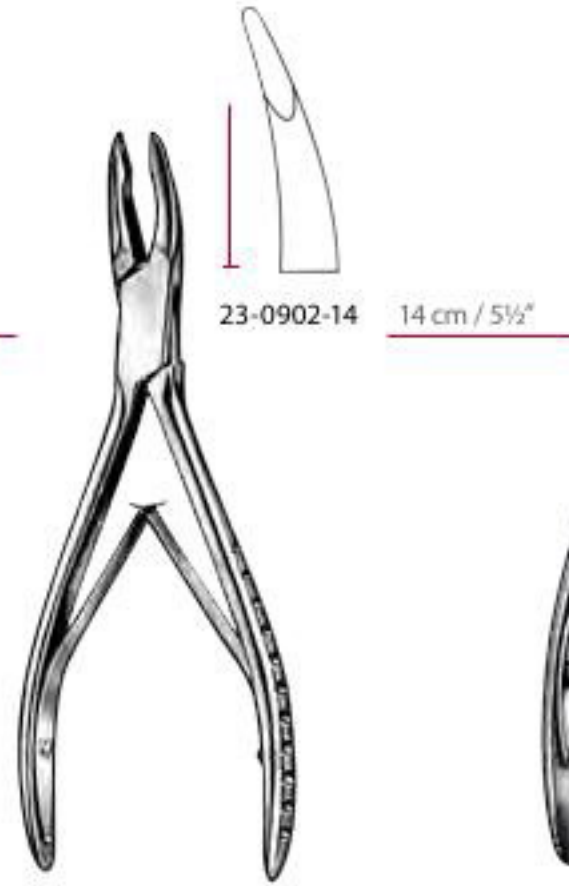

**Micro-Friedmann
Delicate**

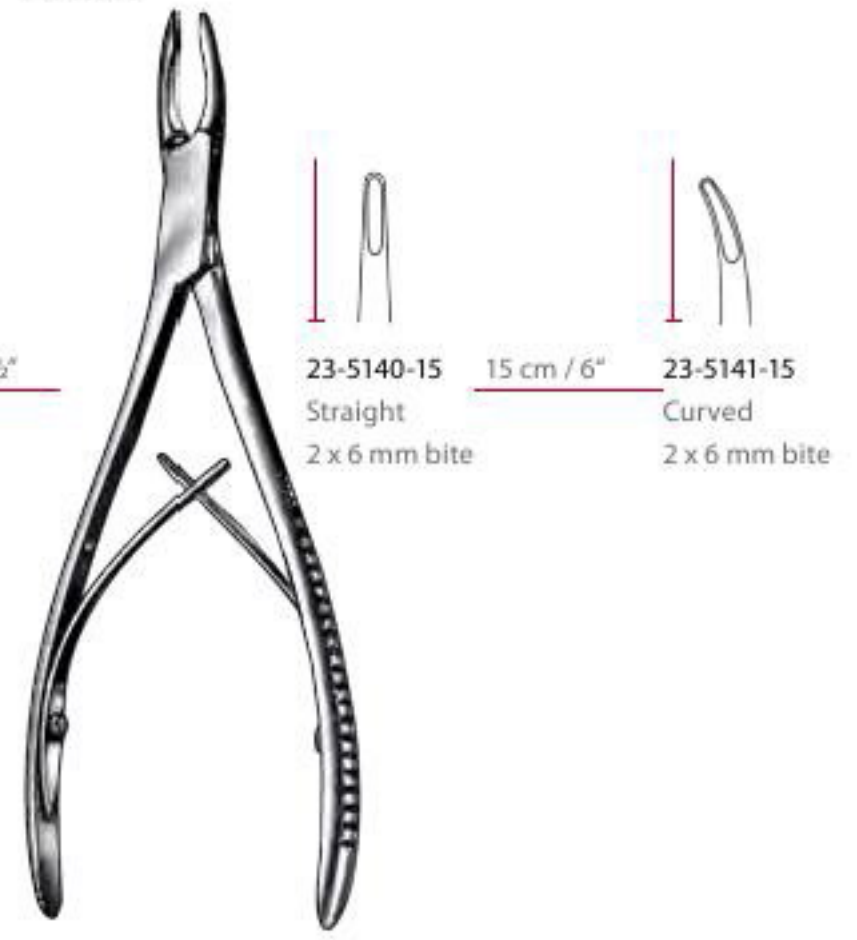

**Micro-Friedmann
Extremely delicate**



Stellbrink

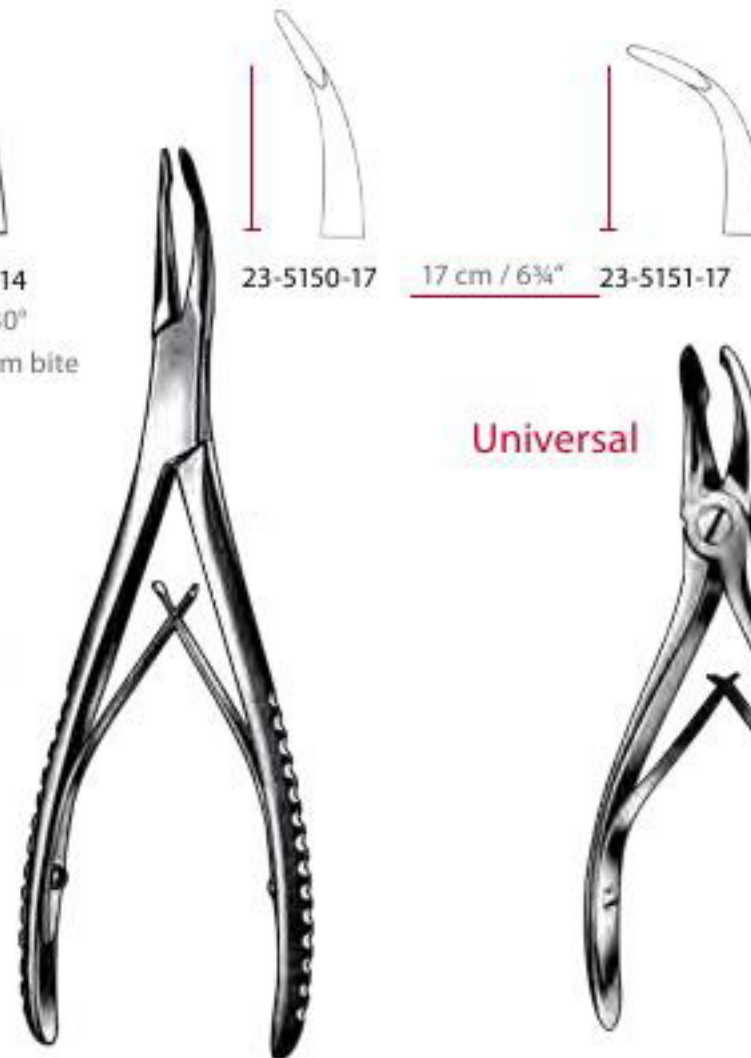

Universal



ORTHOPEDIC Bone Rongeur Forceps

Mead



Mead



Mead

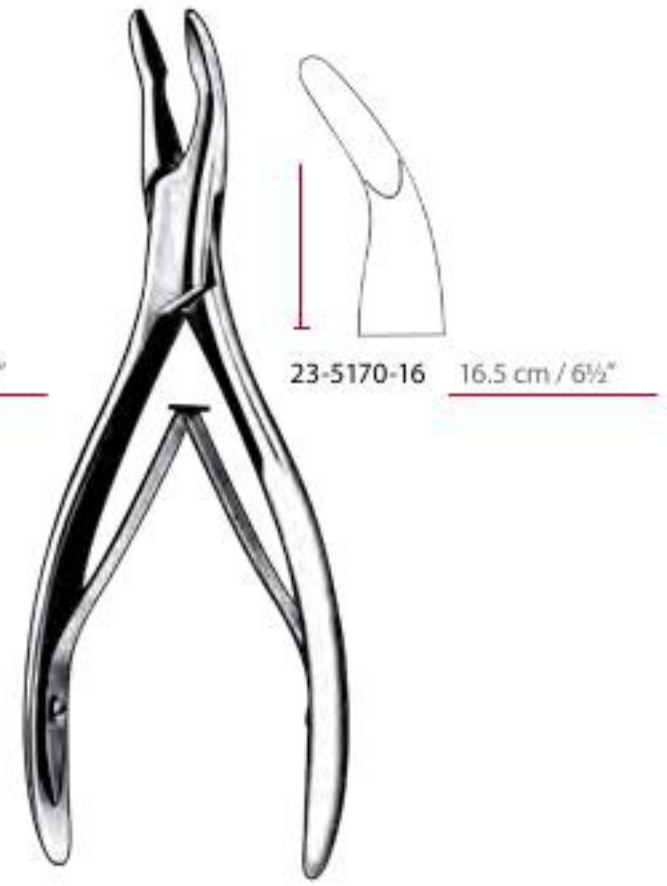

Cleveland

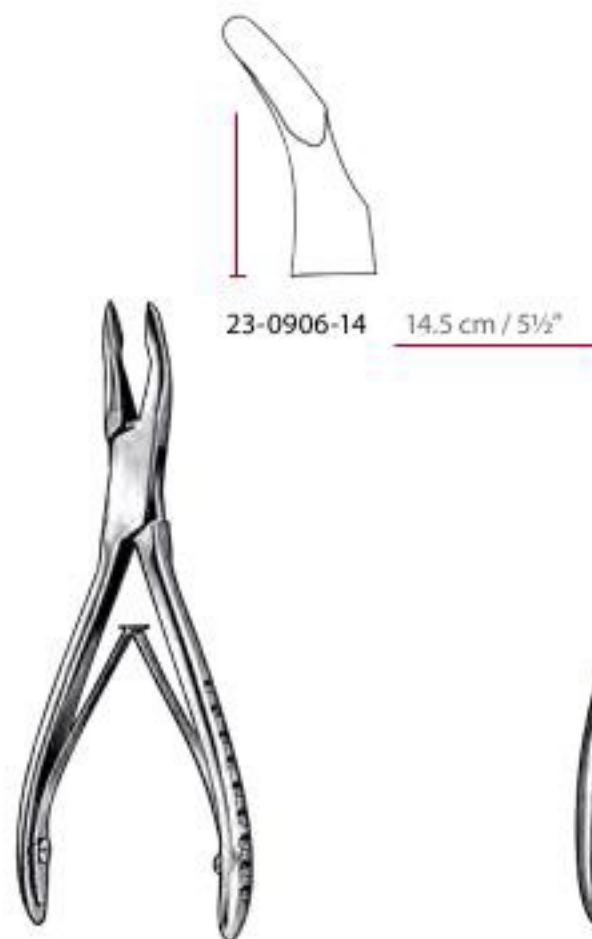

Cleveland

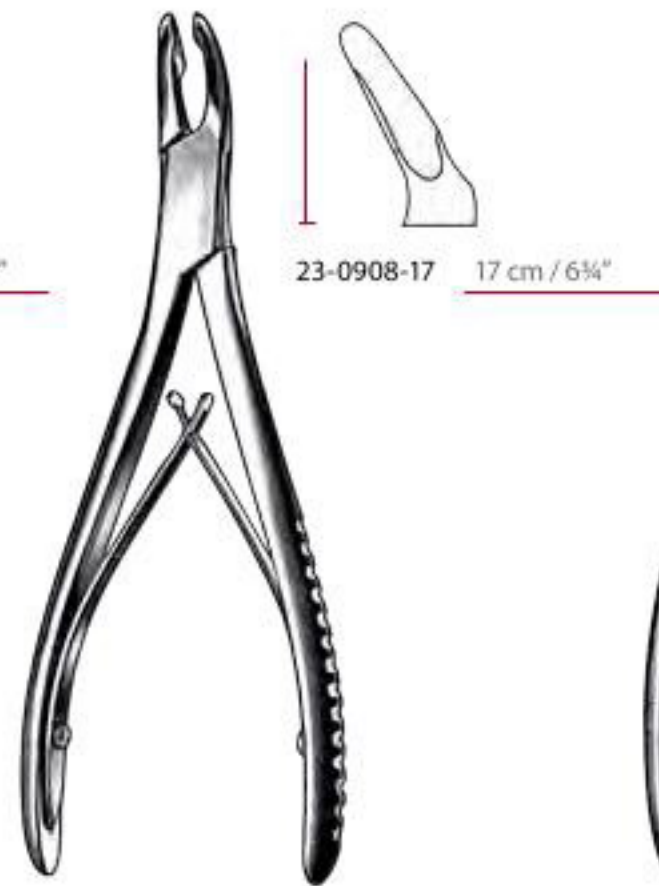

Hartmann



Jansen



Jansen

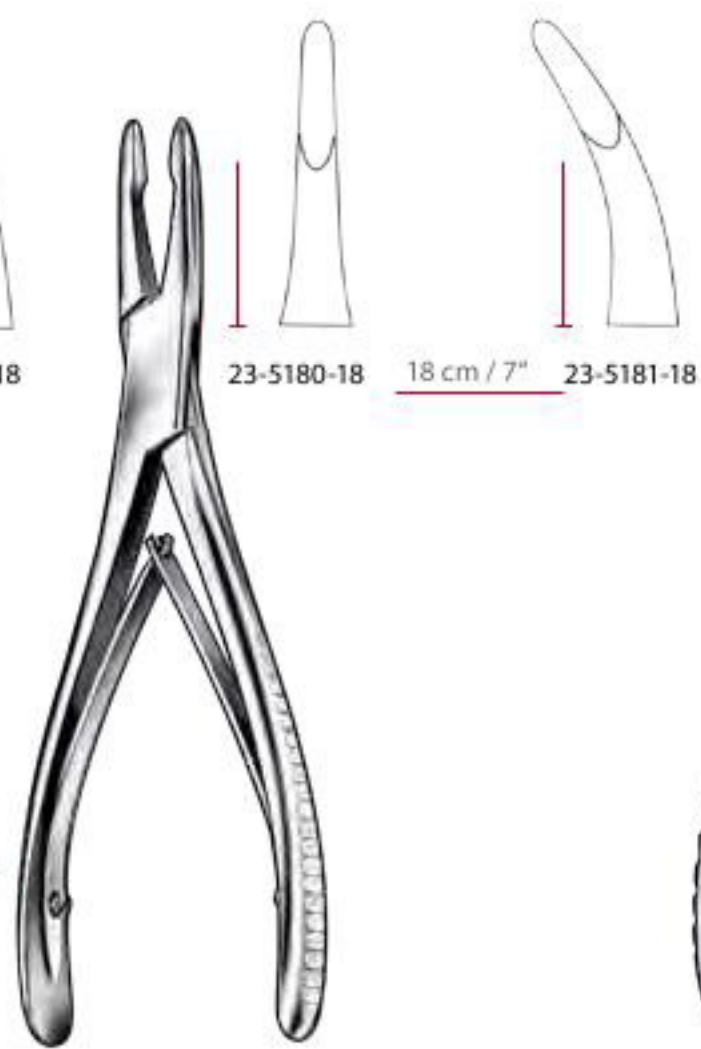

Marchac

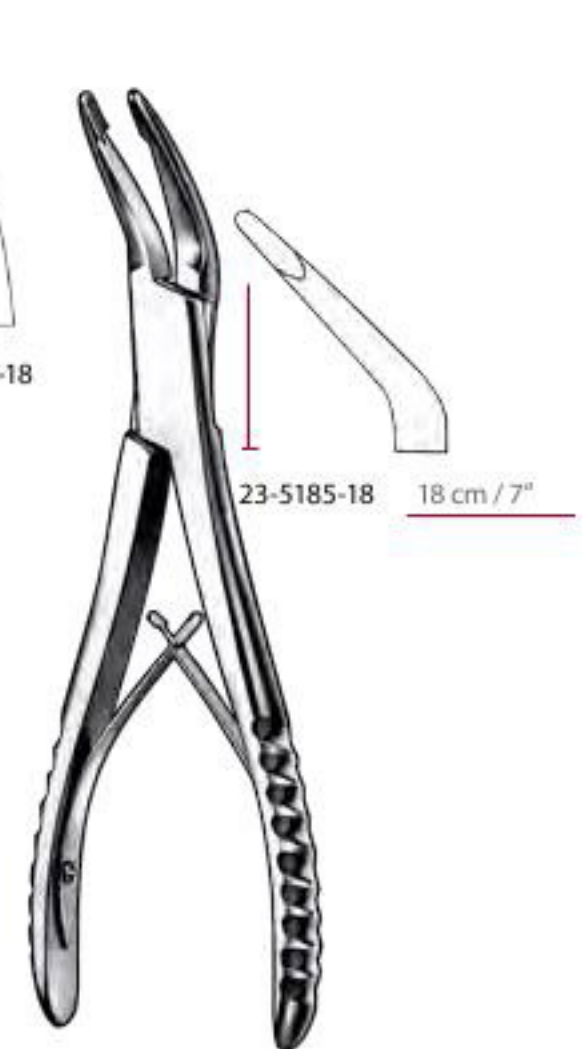

Blumenthal



Luer

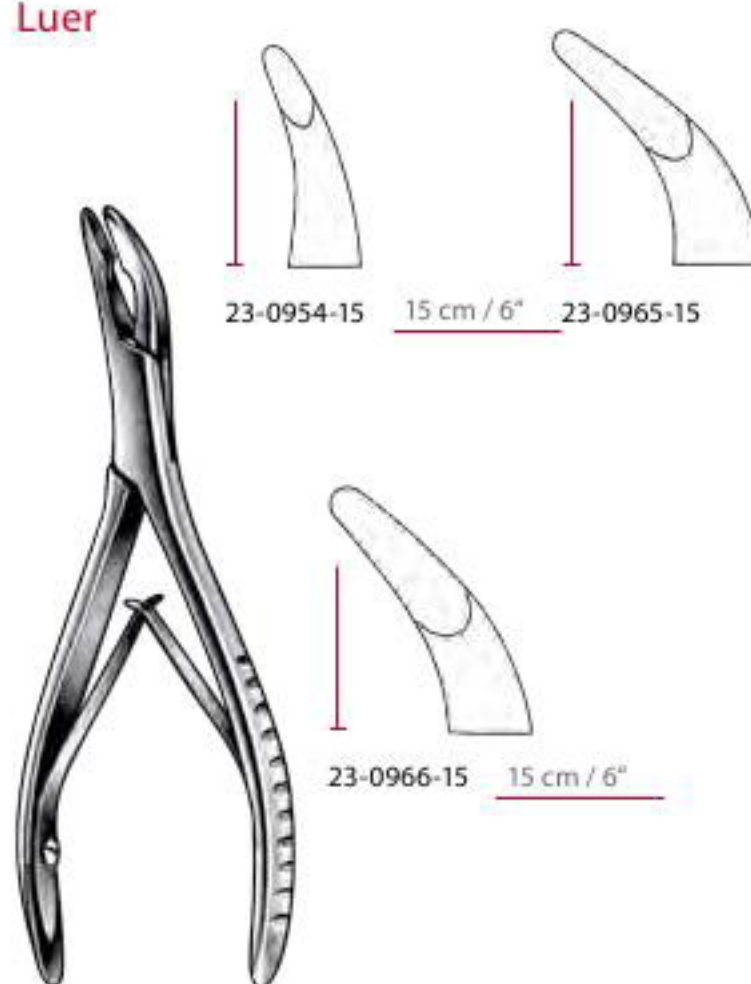

Luer

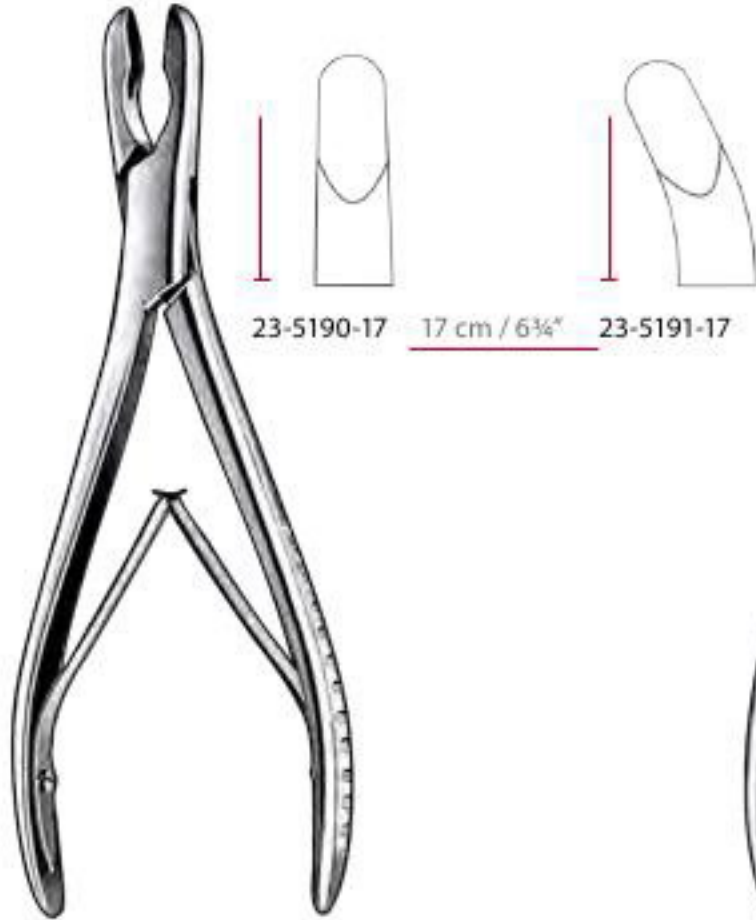

Hakansson



Alexander



Jansen



Beyer



Olivecrona



Guleke



23-5215-20

20.5 cm / 8"

Trotter



23-5220-20

20.5 cm / 8"
Curved to side

Northfield

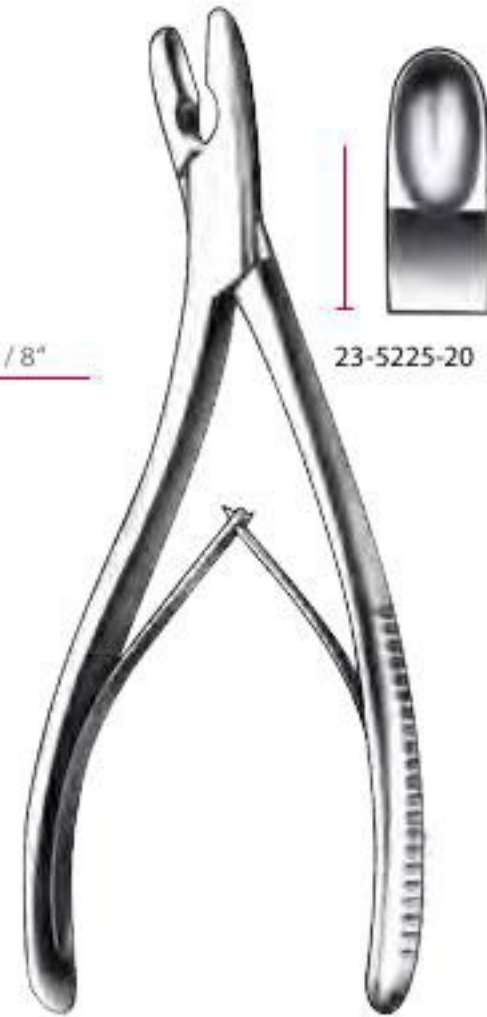

23-5225-20

20.5 cm / 8 1/4"

Pennybacker



23-5230-20

20.5 cm / 8"

Wilms



23-5235-21

21 cm / 8 1/4"

Rat Tooth Rongeur



23-5240-20

20.5 cm / 8"
With teeth
8 x 15 mm bite
Straight

ORTHOPEDIC. Bone Rongeur Forceps

Lempert

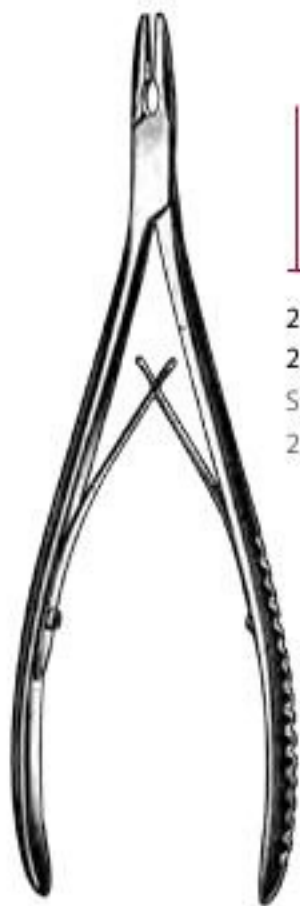

23-5245-16
23-5245-19
Straight
2.5 mm bite

16 cm / 6 1/4"
19 cm / 7 1/2"



23-5246-16
23-5246-19
Curved
2.5 mm bite

Zaufal-Jansen



23-0980-18 18 cm / 7"

Böhler



23-5255-15
2 mm tip

15 cm / 6"



23-5256-15
3 mm tip

15 cm / 6"

23-5257-15
4 mm tip

15 cm / 6"

23-526015
2 mm tip

23-5261-15
3 mm tip

23-5262-15
4 mm tip

**Ruskin
Delicate**



23-2150-15
2 mm
23-5275-15
3 mm
23-5276-15
4 mm
Straight

15 cm / 6"



23-5295-15
2 mm
23-5296-15
3 mm
23-5297-15
4 mm
Curved

23-5280-18
2 mm

17.5 cm / 7"

23-5300-18
2 mm

23-2155-18
3 mm

17.5 cm / 7"

23-0988-18
3 mm

23-5281-18
4 mm

17.5 cm / 7"

23-5301-18
4 mm

23-5282-18
6 mm

17.5 cm / 7"

23-5302-18
6 mm

23-5283-18
8 mm

17.5 cm / 7"

23-5303-18
8 mm

Straight

Curved

23-5285-20
2 mm

20 cm / 8"

23-5305-20
2 mm

23-5286-20
3 mm

20 cm / 8"

23-5306-20
3 mm

23-5278-20
4 mm

20 cm / 8"

23-5307-20
4 mm

23-5288-20
6 mm

20 cm / 8"

23-5308-20
6 mm

23-5289-20
8 mm
Straight

20 cm / 8"

23-5309-20
8 mm
Curved

Mayfield



23-5265-17

17 cm / 6 3/4"

Beyer

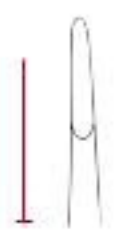

23-5270-18

18 cm / 7"

Straight



23-5271-18

Curved

Ruskin



23-5315-23 23 cm / 9"

Smith-Peterson

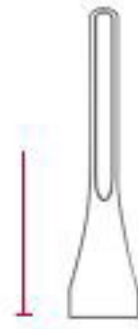

23-5320-24 24 cm / 9½"
Straight
3 x 16 mm bite
Laminectomy
Rongeur



23-5322-24 23 cm / 9"
Full curve
3 x 16 mm bite
Laminectomy
Rongeur

Marquard



23-5325-20 20 cm / 8"

23-5321-24 24 cm / 9½"
Curved
3 x 16 mm bite
Laminectomy
Rongeur

Kleinert-Kutz
Delicate



23-5330-15 15 cm / 6"
2 x 13 mm bite
Synovectomy
Rongeur
Slight curve



23-5331-15 15 cm / 6"
2 x 13 mm bite
Synovectomy
Rongeur
Slight curve



23-5335-15 15 cm / 6"
3 x 8 mm bite
Full curve
Delicate

Kleinert-Kutz
Delicate

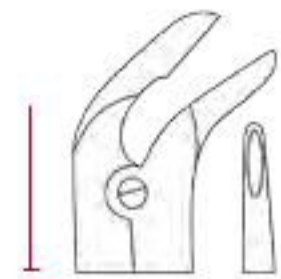







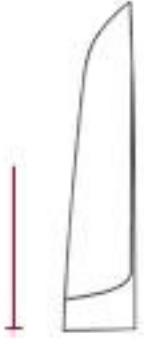

23-5340-15 15 cm / 6"
2 x 10 mm bite
Synovectomy
Rongeur
Curved on side

ORTHOPEDIC. Bone Cutting Forceps

Liston



			
23-5420-14 Straight	14 cm / 5½"	23-5425-14 Curved	23-5425-17 Curved
		23-5420-17 Straight	17 cm / 6¾"
			23-5425-17 Curved
			
23-5420-19 Straight	19 cm / 7½"	23-5425-19 Curved	
		23-5420-22 Straight	22 cm / 8¾"
			23-5425-22 Curved

Cleveland

23-5435-15 15 cm / 6"

Cleveland

23-1040-15 15 cm / 6"
23-1040-17 17 cm / 6¾"

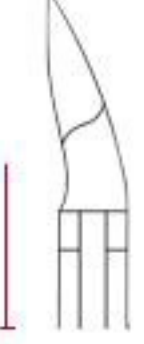
Böhler

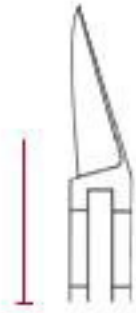

23-5480-14 14.5 cm / 5¾"



23-5485-17 17 cm / 6¾"

Mc Indoe

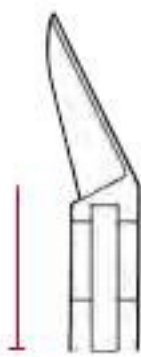

23-5490-17 17.5 cm / 7"

Ruskin-Liston



23-1051-18 18.5 cm / 7¼"
Straight

Liston



23-5495-24 24 cm / 9½"

ORTHOPEDIC. Wire Twisting Forceps with Tungsten Carbide Inserts

Wire Twister, TC

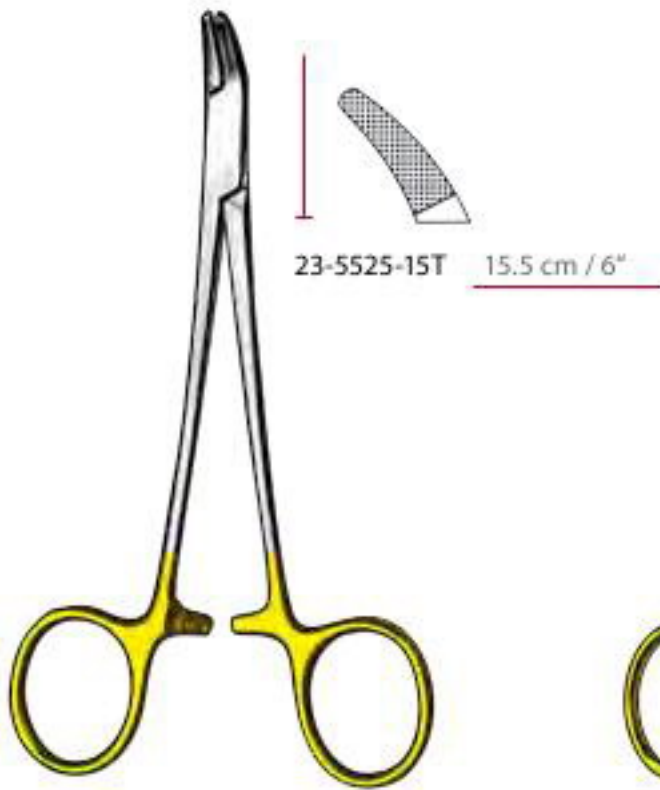

Corwin, TC

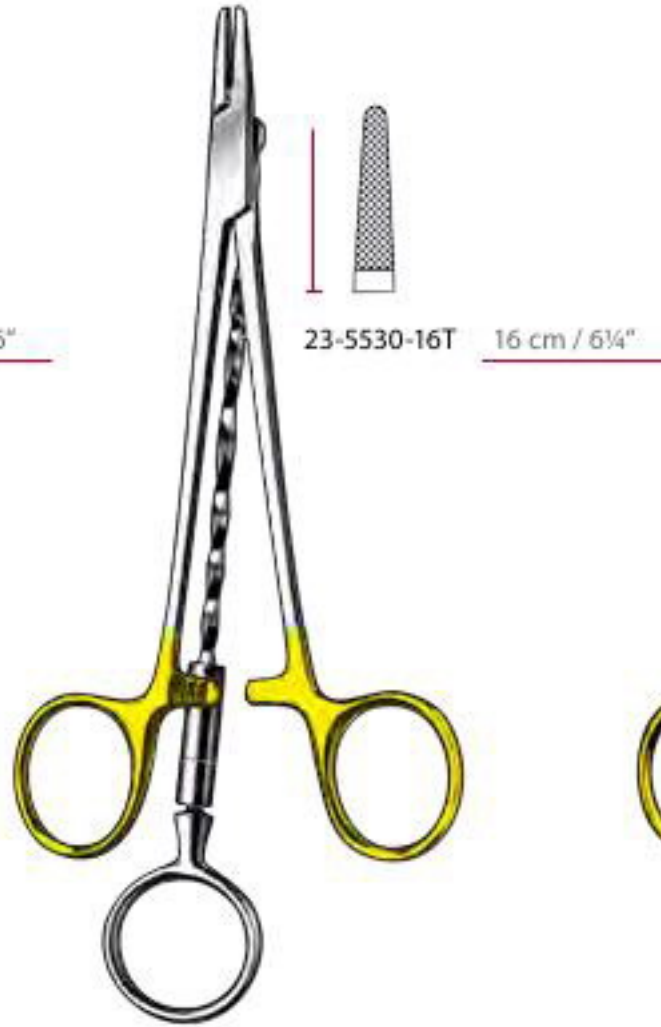

Wire Twister, TC



Wire Twister, TC



Berry, TC

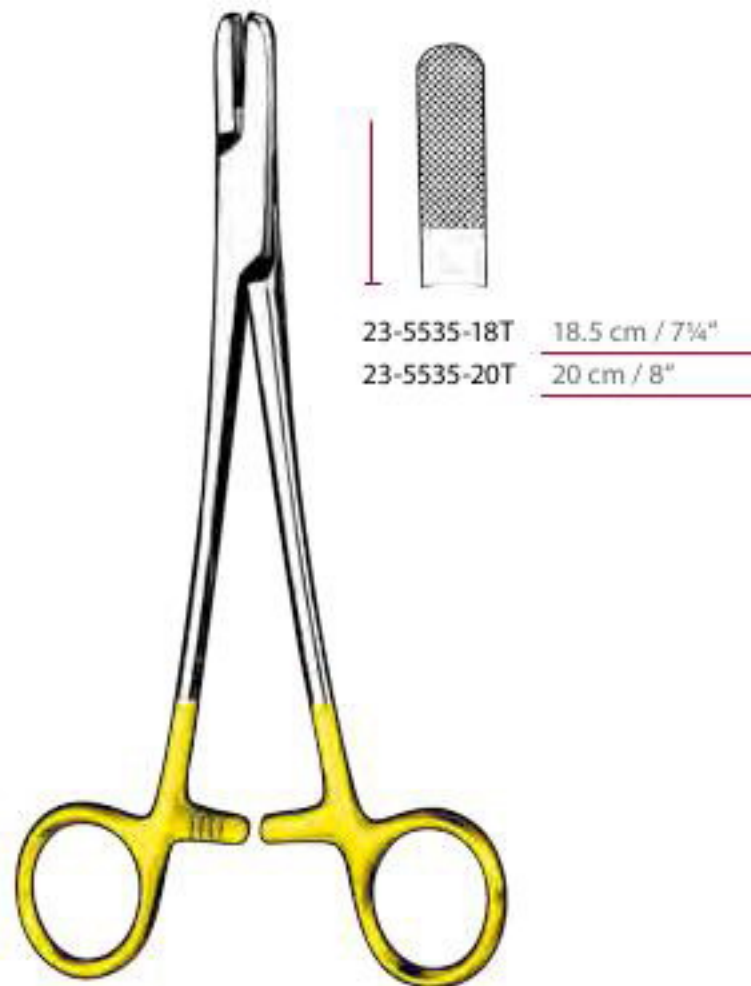

Wire Twister / Cutter, TC



23-5505-17T 17 cm / 6 3/4"

Holding forceps for cerclage wire, with lateral jaws to avoid wire slipping off

Wire Twister, TC



23-5545-15T 15 cm / 6"

Wire tightening pliers
ligature pliers

Flat Nose Pliers, TC



23-5565-18T
Parallel grip

18 cm / 7"

23-5566-18T
Parallel grip

23-5567-18T
Parallel grip

18 cm / 7"

Flat Nose Pliers, TC



23-5570-18T
Parallel grip

18 cm / 7"

23-5571-18T
Parallel grip

ORTHOPEDIC. Wire Twister, Flat Nose Pliers, Wire Cutting Pliers



Hakstock



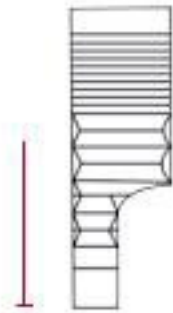

23-5695-20 20 cm / 8"
Slip joint plier
10 mm tip
Maximum opening 2"



23-5655-00
Wire tightener

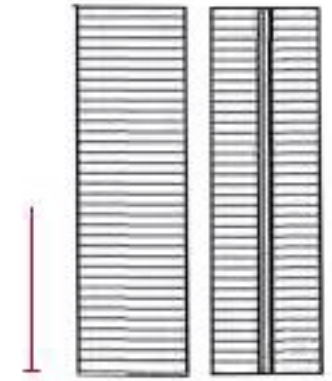

23-5710-13 13 cm / 5 1/4"
23-5710-17 17 cm / 6 1/2"



23-5715-17 17 cm / 6 1/2"
23-5715-12 12.5 cm / 5"
With side cutter



23-5720-18 18 cm / 7"

Diamant

Wire Cutter, TC



23-5770-16 16 cm / 6¼"



23-5775-16 16 cm / 6¼"
for soft wires up to ø2.5 mm
for hard wires up to ø2.0 mm



23-5780-00 16 cm / 6¼"
for soft wires up to ø2.4 mm
for hard wires up to ø1.8 mm



23-5785-16T 16 cm / 6¼"
23-5785-18T 18 cm / 7"
23-5785-20T 20 cm / 8"

Wire Cutter, TC

Wire Cutter, TC

Wire Cutter, TC



For up to 1.6 mm

23-5790-14T 14 cm / 5½"
23-5790-16T 16 cm / 6¼"
23-5790-18T 18 cm / 7"

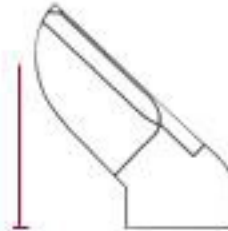

23-5795-22T 22 cm / 8¾"
for soft wires up to ø2.6 mm
for hard wires up to ø2.2 mm



23-5801-14T 14 cm / 5½"
23-5801-16T 16 cm / 6½"
23-5801-18T 18 cm / 7"
23-5801-22T 22 cm / 8¾"
for soft wires up to ø3 mm
for hard wires up to ø2.2 mm

Wire Cutter, TC
Front and Side



23-5805-15 15 cm / 6"
for soft wires up to \varnothing 2.0 mm
for hard wires up to \varnothing 1.2 mm



23-5810-24 24 cm / 9½"



23-5815-18T 18 cm / 7"
for soft wires up to \varnothing 2 mm
for hard wires up to \varnothing 1.5 mm

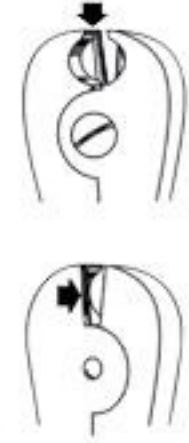

Front Pin Cutter, TC



23-5825-22T 22 cm / 8¾"
for soft wires up to \varnothing 3.5 mm
for hard wires up to \varnothing 2.5 mm



Wire Cutter, TC



23-5820-17T 17 cm / 6¾"
Angled slender
pattern for wire
removal (for soft
wire)



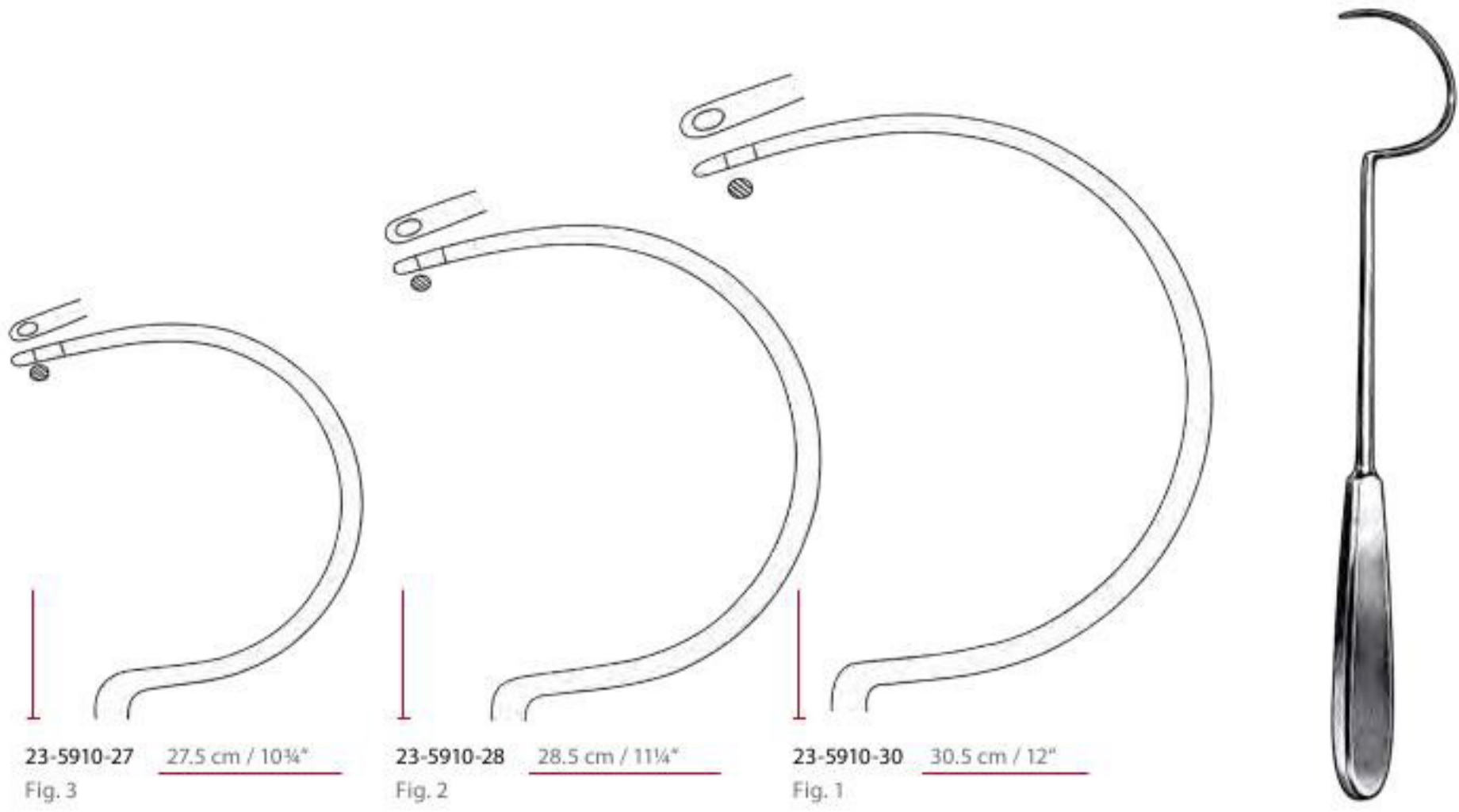

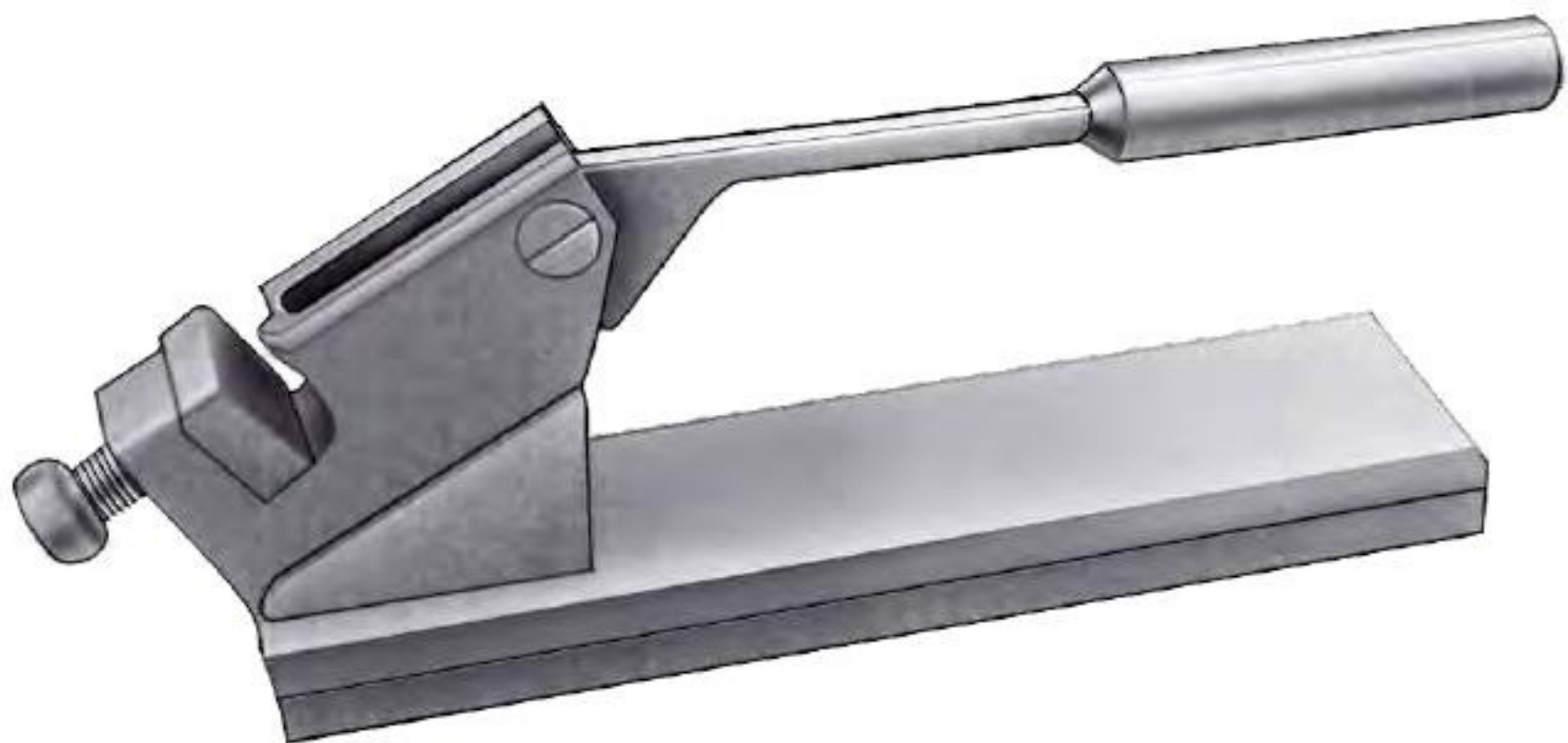

23-6045-00
Large bone plate press

23-6046-00
Small bone plate press

Contents list

Scalpel Handles	
Scalpel Handles	04-05
Forceps	
Artery Forceps	06
Artery Forceps, Delicate	07-08
Delicate Artery Forceps	09
Artery Forceps	10-11
Tissue, Organ Grasping Forceps & Angiotribes	12
Towel Forceps	13
Cotton Swab Forceps – Sponge Forceps	14
Dressing & Tissue Forceps	
Dressing and Tissue Forceps	15-16
Micro Forceps, Splinter Forceps	17
Dissecting Forceps	18
Scissors	
Operating Scissors	19-21
Dissecting Scissors	22-23
Dissecting Scissors, Fino-Line	24
Fine Operating Scissors	25
Fine Operating Scissors & Ligature Scissors	26
Operating Gum & Ligature Scissors	27
Micro Scissors	28
Bandage Scissors	29
Scissors with Tungsten Carbide Inserts	30-33
Needle Holders	
Needle Holders	34-40
Retractors	
Retractors	41-42
Hooklets	43
Micro Hooklets, Skin Hooks	44
Saddle Hooks, Hooklets	45

Contents list

Retractors

Hooklets	46
Wound Spreaders, Self-retaining	47
Retractors	48
Wound Spreaders, Self-retaining	49
Retractors	50
Abdominal Retractors	51

Orthopedic

Mallets	52
Bone Files, Bone Levers	53
Nasal Rasp, Bone Files	54
Bone Files	55-56
Wire Saws	57
Bone Curettes	58
Bone Osteotomes Chisels And Gouges	59
Bone Osteotome Chisels	60
Elevators	61
Periosteal Elevators	62
Bone Levers	63-64
Bone Holding & Reduction Forceps	65-69
Bone Holding Forceps	70-72
Bone Holding Clamps, Traction Bar	73
Bone Holding Clamps	74
Bone Rongeur Forceps	75-81
Bone Cutting Forceps	82-83
Wire Twisting Forceps, Tungsten Carbide	84
Wire Tightening Pliers, Flat Nose Pliers, Tungsten Carbide	85
Wire Twister, Flat Nose Pliers, Wire Cutting Pliers	86
Wire Twister & Wire Cutting Pliers	87
Wire Cutting Pliers	88-89
Bone Wire Guides	90
Bone Plate Benders	91

Important Notice:

This is our General Catalogue which remains our exclusive property.
 Change of design and pattern reserved. Re-printing, even in parts, is not permitted.
 All business is subject to our General Terms of Sale. As of July 2009

Med Veterinary Instruments



MED-SURGICAL INSTRUMENTS

724, Thornhill Drive
Coliegeville. PA 19426.
TEL: +1 610-983-3073

www.medsurgicalusa.com